



MISSION STATEMENT

We provide solutions through knowledge, ensuring a profitable and sustainable pork industry for our stakeholders and staff.

Table of Contents

2012-2013 Report Highlights	3	NUTRITION	
REPORTS		Creep Feeding in the Farrowing Room: Do the Outcomes Depend on Weaning Age?	35
Chairman's Report	4	Spray-dried animal plasma mitigates the negative impact of deoxynivalenol (DON) in nursery pigs	38
President's Report	5	Effects of Altering the Omega-6 to Omega-3 Fatty Acid Ratio in Starter Diets on Piglet Inflammatory Response	41
Technology Transfer Report	7	The Efficiency of Energy Utilization by Finishing Pigs Selected for Potential Growth Rate	43
Operations Manager Report	8	Impact of Calcium and Phosphorus on Sow Lameness and Sow Longevity	46
MANAGEMENT		PUBLICATIONS LIST	49
Prairie Swine Centre at Work	9	FINANCIAL SUPPORT	52
Corporate Objectives	10		
Research Objectives	11		
ENGINEERING			
Benchmarking and Standardization of Swine Production Systems	12		
Evaluation of a Commercial-Scale Air Treatment System	14		
Development of an air filtration system for swine transport vehicles to protect against airborne diseases during transport	17		
ETHOLOGY			
Temperament traits related to stress and meat quality: Are they reliable and heritable?	19		
Investigation of translactational analgesia for reducing piglet pain at castration	22		
Early Detection and Interventions for Reducing Lameness in Gestating Sows	25		
Effect of Rubber Flooring and Social Grouping on the Utilisation of Free Space for Sows in Walk-in/lock-in Stalls	29		
Identifying the cause of death of hogs that perish in-transit: A pilot project at Two Ontario packing plants.	32		
Enhancement of litter size in commercial swine	34		

2012-2013 Report Highlights

14 key areas of swine barn design and management have been identified through producer survey as areas that could benefit from standardization and optimization efforts.....Page 12

A commercial scale bio-trickling air treatment unit was effective in reducing the levels of ammonia, dust, and odour from growing and finishing rooms by 77%, 92%, and 75% respectively.....Page 14

Design of a air filtration system developed to filter incoming air in transportation trailers, to protect high value animals from airbourne transmissible diseases.....Page 17

Initial results indicate finishing pigs can be selected for reduced stress response.....Page 19

Results indicate the transfer of analgesic (Metacam), to sow's milk was not effective in providing pain relief for piglets.....Page 22

Preliminary data suggest that preventative hoof trimming, using a Zinpro FeetFirst chute, reduces the occurence and severity of lameness in gestation.....Page 28

Sows spent significantly more time in areas with rubber flooring than concrete flooring regardless of age of sow.....Page 29

Slow, low stress handling and keeping hogs cool during loading and transport continue to be the most practical recommendation for reducing transport deaths.....Page 32

Body weight at nursery exit was greater in piglets offered creep feed for one week prior to weaning, however less than 40% of piglets consumed creep.....Page 35

Pigs fed a DON contaminated diet plus spray-dried blood plasma performed as well as pigs consuming non-contaminated diet.....Page 40

Weanling pigs fed diets containing different n-6:n-3 fatty acid ratios responded differently to an LPS induced immune challenge.....Page 41

Pigs separated into slow, average or fast potential growth rates, by determining their growth rates in the nursery have comparable growth rates and feed intake.....Page 44

Chairman's Report

Finding Solutions in Challenging Times

DR. MARY BUHR, Chairman of the Board



I've had the honour of chairing the PSC Board of Directors for the past year, it truly has been an honour to work with the dedicated volunteers that serve the PSC and the swine industry in general. The Board members devote considerable time to providing PSC guidance and advice during the official Board meetings, but provide even more support through their daily activities that take them into the industry throughout the year. They gather and share their knowledge and insights back and forth among their industry contacts and PSC, and we all benefit because of that.

But the thing that really makes PSC shine is the amazing people who work every day at the Centre. The office and barn staff, the scientists and students – heck, even the official mouse catcher – all clearly are committed to supporting the Centre and seeing it succeed. If you get a chance to tour the facility, you'll see for yourselves the determination to make it work, the pride in having a high-class facility that's making a difference to an important industry, contributing to the economy and to feeding the world. And the sense of community and friendship is also clear.

A lot of credit for this goes to Lee Whittington. He has seen the Centre through some pretty tough times, and the Centre is in a much stronger situation now than it has been for years. Certainly there are still a lot of challenges to deal with, but the Board has faith and confidence in Lee's leadership and ability to keep Prairie Swine Centre a vibrant and healthy facility. A major new initiative now underway is to set up a National Chair in Swine Welfare, building on the Ethology program established at the Centre 20

years ago. The Board believes this aspect of swine production will continue to grow in importance, and that it is critical to provide solid facts and evidence to inform and support decision-making by producers and consumers. Fund-raising efforts have the Centre well on the way to securing a world calibre researcher to lead this effort and grow the Centre's already well-recognised prominence in swine welfare and production.

This year's Annual Report summarizes the Centre's performance over the year. It is one that the Board is proud of, and we salute the hard-working men and women who have made this success possible. But even more importantly, we salute the knowledge and support that the Prairie Swine Centre provides the swine industry.

Regards,
Mary



Board of Directors

*Back Row L-R: Brad Marceniuk, Judy Yungwirth, Darcy Fitzgerald, Wayne Thompson, Jim Bassinger, Walter Heuser, James Ressor, John Carney
Front Row L-R: Lee Whittington, Mary Buhr, Rick Prejet*

President's Report

Prairie Swine Centre Celebrates 20 Years – People Make it happen

LEE WHITTINGTON, B.Sc. (Agr) • MBA • CEO / President



We have much to be thankful for. That may seem an odd statement when we consider the challenges the industry has faced the past 5 years and continues to face as businesses exit pork production. In times like these it is easy to forget that the past 20 years has seen tremendous growth (still our industry is 30% larger than in 1992), the genetics, health, housing and nutrition combining to produce a breeding herd capable of producing 30% more pigs from each sow, resulting in a market hog growing 1/3 rd faster and producing a carcass 20% heavier. In fact in less than 30 years the total meat output of each sow has doubled.

So I want to dedicate this 2012 Annual Research Report to the people that have made the pig their life's work. To those who work with the animals, ensuring not only excellent production but excellent welfare, and to those that work for the pig farm's wellbeing in the development of the sector such as in service positions as sales representatives, veterinarians, and feed manufacturers. The industry is filled with such people who recognize the importance of the pig in the future of the animal agriculture economy as a solution to the protein and calorie shortfall predicted to be required to feed a growing world population. One estimate concludes that 70% of the solution to agriculture meeting world food expectations will be attributed to the application of technology. The people at Prairie Swine Centre have a role to play in making Canadian pork producers a competitive alternative through improved knowledge in technical pork production.

Our volunteer Board of Directors represents pork producers, animal health, pork processing, grains industry, university and government. The board provides insight and links required for our success. – Thank you.

The industry continues to invest in research and although total investment in research has fallen since 2005, all of our major funding sponsors have maintained a significant investment. A special thank you to Manitoba Pork and Sask Pork for their supplementary core funding in 2012, and to Ontario Pork for joining as a core partner. To our funding agencies, sponsoring corporations and governments which are all named on page 48 – Thank you.

Our enthusiastic and creative staff every day manages the industry's investment in research, generates new ideas to keep farms competitive and go to meetings and special events all year round providing a positive representation of the industry and answering the question "Whats new" – Thank you

Within this document you will be exposed to our latest thinking, findings and activities. We hope you find the publication useful in your role as one of the industry's MVP's (Most Valuable people) – Thank you
Sincerely,

Lee Whittington
President/CEO



Our Mandate

To produce and distribute knowledge derived through original research, scientific review and economic analysis.

Our Vision

To be an internationally recognized source of original, practical knowledge providing value to stakeholders throughout the pork value chain.

Our Mission

We provide solutions through knowledge that ensure a profitable and sustainable pork industry and in so doing secure a prosperous future for our stakeholders and staff.

Technology Transfer Report

Providing Producers Answers at Their Fingertips

KEN ENGELE, B.S.A. • Manager, Information Services



Relationships between the Centre and the pork industry are ever-increasingly important. As the Canadian pork industry continues to go through structural change, who and how we communicate research results also changes. Looking back over that last 20 years of the Centre we still rely on three areas of communication: in-person, publication, and electronic. However the biggest change comes in how we use, and the relative importance of each one of these communication methods.

The static aspect of the Technology Transfer program is in-person communication; phone calls and meetings still provide pork producers direct access to the Research Scientists. This provides invaluable information to producers, in addition to informing Research programs at the Centre, by receiving immediate feedback on the relevance of research programs. The biggest shift comes in the movement to electronic communication, largely at the expense of print. Our program is largely setting www.prairieswine.com as the clearing house for all information generated at the Centre in addition to peer-reviewed material that would benefit pork producers through the industry. It also meets the needs of push versus pull information: producers can access information when they want it in addition to having a credible source of information that can be driven into the industry.



One of the ever-growing segments of communication plan is social media. Helen Thoday was brought on-board to the technology Transfer program to head up the development and implementation of a Social Media strategy. The social media strategy will follow an integrated approach that will compliment other aspects of the Technology Transfer program.

In order to maintain and increase the Prairie Swine Centre brand – 2013 will see increased Prairie Swine Centre communication with the pork industry. July will include an intensive Technology Transfer planning session identifying when, and what form of communication will occur with the industry.

Program Objectives

- To effectively communicate the knowledge generated at Prairie Swine Centre to pork producers and other key players that help support the pork industry throughout Canada.
- To support Prairie Swine Centre's role as a Regional Initiative – A National Resource.



Swine Innovation Porc

Operations Manager Report

Managing Increased Productivity

BRIAN ANDRIES, BSA • Manager, Operations



Production continues to improve over the past year, especially in numbers born alive and numbers weaned, as indicated below. We have decreased the number of sows bred weekly from 16 to 14, but with large numbers born alive, we can easily increase weekly targets by putting together new litters on at least 1 or 2 nurse sows weekly (due to litter size). Additional production has provided the opportunity to sell additional nursery pigs, in addition to University researchers, a local abattoir and others have kept crowding at bay and room and animal flow have been easily managed. There has been an increase in activity from researchers on campus that has put some strain on animal and room availability for our researchers, but internal and external researchers have been able to work together and are happy with the schedules that have been developed.

“Whole herd farrowing rate has improved to 97.7%”

We have always struggled with the negative costs that research has on production. Historically losses have been charged for pigs that can't be sold due to sample collections or physically not been able to enter the food chain, extra feed costs for research diets, losses at market for selling animals either light or heavy depending on protocols or production labour helping with research trials. Policies have been developed that deal with the breeding herd looking at specific charges per sows for trials that may have an effect on farrowing rate. Charges are based on the previous 2 years farrowing rate and the current number of pigs weaned per sow and paid on pigs lost per open sow. If Researchers wants to use all sows in a farrowing group which will impede the ability to early wean 1 or 2 sows a week as nurse sows then the trial is responsible for these losses as well. This is based on the total number of sows put on trial, and the productivity losses will be calculated at 1 pig lost per litter on trial.

Table 1. Production parameters*

Category	09-10	10-11	11-12	12-13 (Jan-May)
Sows Farrowed, #	692	686	780	219
Conception Rate, %	87.0	92.7	93.4	94.1
Farrowing Rate, %	85.1	92.7	93.0	97.7
Avg. Pigs Born Alive/Litter	12.0	12.7	13.0	13.7
Farrowing Index	2.46	2.48	2.48	2.48
Number Weaned/Sow	10.6	11.7	11.9	12.5
Pre-Wean Mortality, %	14.6	12.7	10.7	14.2
Pigs Weaned / Sow / Yr	24.1	26.5	26.8	28.0
Sow Non-Prod. Days/Sow/Yr	32.8	27.2	24.3	28.0

*2009-10, 2010-11, 2011-12, 2012-13 (first 16 weeks)

The national body of the Council on Animal Care were here to evaluate our facility for research purposes. They tour all research facilities in Canada every 3 years and are closely associated the University of Saskatchewan's Animal Care Committee that approve all research trials. They seemed were impressed with the facilities and more so with the state of all animals currently on farm. One person on the panel is a veterinarian who now works at the Veterinary Medicine facility in Calgary and was previously employed with Dr. Sawatsky for a number of years while in Saskatchewan. He commented that he has never seen a so well run swine operation which is a great attribute to what the staff is doing on a daily basis. The final report from the committee will not be available for 2-3 months but comments at their closing meeting after all campus tours were completed to discuss any deficiencies, excluded Prairie Swine Centre from any comments. They did comment that all animal facilities associated with the University of Saskatchewan were well run and complimented facility managers in the operation of these facilities.

2012 saw a total of 5,480 animals on trial. Half way through 2013 we have started 17 trials and currently have put 3,485 animals on trial.

An agreement with Sapputo has provided Prairie Swine Centre an opportunity to utilize whey within the feeding program, saving and estimated \$7-9 per hog. Separate water lines have been installed in all animal rooms. We are waiting for a couple of electronic components to finish the set up of the delivery system. We are currently working with Gowens Feed Consulting to change our grower and finisher diets to accommodate the whey.

Prairie Swine Centre at Work

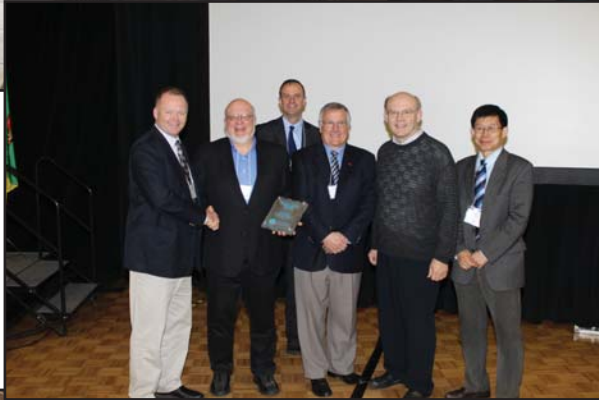
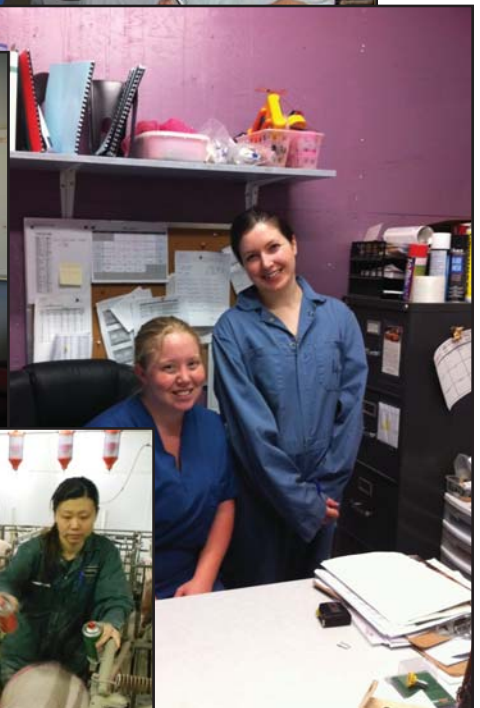

Corporate Objectives

Objective #1

To be a profitable organization operating in a marketplace that offers growth opportunities.

Objective #2

To meet the technology needs of the pork value chain better than any competitor - defined as all stakeholders in the pork value chain from cereal development to consumer acceptance of pork. Using an industry-oriented and multidisciplinary approach that ensures timely adoption of knowledge.

Objective #3

To leverage our strengths and capabilities as a 'knowledge-based' company.

Objective #4

To provide scientific leadership in our areas of expertise to industry, university and government.

Objective #5

To define 'Best in Class' and benchmark against critical efficiency, innovation and accountability metrics (in operations, human resource, financial, and scientific output).

Objective #6

To empower our people – that they should feel Valued, Challenged and Engaged in a safe work environment. Assisting them to find the breakthroughs to take us to the next level.

Objective #7

To enhance the Centre's effectiveness and sustainability, through successful collaborations, co-operative action and strategic alliances in our research, education and technology transfer roles. This objective applies equally to initiatives within Prairie Swine Centre as well as relationships with external institutions/agencies.

Research Objectives

Serving the Needs of the Pork Value Chain

Objective #1

To increase net income for pork producers through improved nutrition. This includes the development of feeding programs which emphasize economic efficiency, meat quality, and market value. Also understanding feed and fibre sources and the modifications of these to meet the needs of the pig, changing economics and opportunities to favourably impact meat quality.

Objective #2

Improve animal wellbeing by developing and modifying housing systems, animal management practices, and health of the pig.

Objective #3

To improve barn environment through the development of economical and practical techniques ensuring the health and safety of barn workers and animals.

Objective #4

To reduce the environmental footprint of pork production through breakthroughs in the science of odour and gas emissions, nutrient and water management, utility and resource efficiency.

Objective #5

To address the needs of society by leveraging our knowledge of the pig. This includes for example, using the pig as a model for human health and nutrition, for pet nutrition.

Our Commitment

To meet or exceed the research data and scientific analysis expected by our clients, and demanded by regulatory guidelines.



Benchmarking and Standardization of Swine Production Systems



B. Predicala, A. Alvarado and L. Whittington



Bernardo Predicala



Alvin Alvarado

SUMMARY

Previous work have shown that even though the ultimate goal of a swine production operation is to raise hogs in the best possible manner, there is a wide variation in the different operational systems in place in swine facilities across the industry, leading to variability in performance, efficiencies, production costs, and overall productivity. The overall goal of the project was to evaluate the current performance of various operational systems in swine production to determine whether standardization and optimization can improve efficiencies and overall productivity. From the work conducted in this project, 14 key areas of swine barn design and management were identified by pork producers and other stakeholders as areas that could potentially benefit from standardization and optimization efforts.

INTRODUCTION

During the investigation of past projects involving characterization of various swine production systems, it became apparent that inefficiencies and added costs in many hog barns can be traced to a number of areas: wide variations in building design, construction, barn equipment, management, and other operational systems.

Results also indicate, that for the most part there is no clear reason for the variability except for the lack of applicable standards to guide the producers. Ultimately, this wide variability makes it difficult to develop improvement measures that can be easily applied from barn to barn, or at least to the majority of hog barns currently in operation.

The lack of standards or optimization is evident in a number of examples pertaining to swine production. A Prairie Swine Centre study showed a four-fold difference in total energy usage between barns employing energy-efficient practices compared to other barns of the same type but has not put emphasis on efficient use

of energy in their operations. Within barns, various issues related to animal welfare such as lameness and stress could be avoided if appropriate standards are available for loading ramps, floor surface roughness, floor slat designs, pen walls, and alleyways. Anecdotally, there are other various examples that can be found across the industry that illustrate the wide variations in the manner by which ‘common’ production practices are implemented from barn to barn.

The overall goal of this project was to benchmark the existing operational systems in a modern swine production operation in order to develop recommendations for optimization and standardization of these various systems.

“14 key areas of swine barn design and management were identified by pork producers as areas that could potentially benefit from standardization and optimization efforts“

RESULTS AND DISCUSSION

An initial survey of pork producers and related industry stakeholders to assess the awareness and application of existing standards and guidelines in current pig production systems showed: **a.** heavy reliance on “**rules of thumb**” for most of the decisions on design, construction and operation of pig barn systems (e.g., manure storage, flooring, ceiling height, pen size, stocking density), and **b.** most of the operational issues commonly encountered in the surveyed production barns seemed to be related to these areas. In contrast, for areas where there are numerous existing regulations and standards covering product specifications, installation, and performance, producers did not report many associated problems (e.g., 96% of pork producers reported no problem with their electrical system, which is a system governed by several existing codes and standards).



From the survey and interviews, the 14 key problem areas identified by pork producers include:

- a. dry sow stall
- b. farrowing crate
- c. ceiling height
- d. alley and/or hallway width
- e. space requirements for pigs
- f. load out
- g. flooring type
- h. slatted floor
- i. manure handling inside the barn
- j. manure storage external to barn
- k. manure handling activities
- l. feeders and drinkers
- m. commissioning and calibration of equipment
- n. emergency power and water systems.

A second survey focusing on the above areas was conducted with invited respondents from among pork producers across Canada. Out of all respondents, only 18% reported no problems with any of the 14 areas identified. Among those who reported encountering issues, the areas most frequently cited are feeders and waterers (40.9%), space requirements and crowding (39.4%), loadout (34.8%) and farrowing crates (31.8%). The specific problems reported include over-crowding, caused by increased prolificacy of breeding herd surpassing the original barn design specifications and changing market conditions resulting to higher or lower market weights of finished animals. Other physical system commonalities among producers include over 90% of complaints on barn load out designs implicating ramp angle and width as the primary problem, as well as 15-17% of all respondents having identified flooring type and slatted floor designs as problem areas associated with sow lameness and longevity.

CONCLUSIONS

The project determined the main gaps regarding the building, equipment and manure storage/handling which proved to be the most common problem areas for pork producers. By identifying widespread problem areas, we can develop priorities for swine barn research to fill the gaps determined in this project and focus efforts on improving these areas to the benefit of producers and pigs.

ACKNOWLEDGEMENTS

Strategic funding provided by the Saskatchewan Pork Development Board, Alberta Pork, Manitoba Pork Council and the Saskatchewan Ministry of Agriculture. The authors would like to acknowledge the Saskatchewan Agriculture Development Fund and the Canadian Swine Research and Development Cluster (CSRDC) for the financial support to this research project.



Evaluation of a Commercial-Scale Air Treatment System



B. Predicala, A. Alvarado, M. Girard, M. Belzile, S. Lemay, and J. Feddes



B. Predicala



Alvin Alvarado

SUMMARY

An air cleaning technology based on biotrickling filtration developed in previous phases of the project was scaled up and tested at the PSC swine grower-finisher facility. Results showed that the air treatment units were effective in reducing the levels of ammonia, dust, and odour from the airstream at the exhaust of the grow-finish rooms by about 77%, 92%, and 75%, respectively. Further work is needed to optimize the operation of these units in terms of water usage and to assess its year-round performance.

INTRODUCTION

Animal housing can emit substantial amounts of aerial contaminants such as odorous compounds, ammonia, hydrogen sulphide, airborne particulates, and pathogens. Since total removal of ammonia and odour is not possible within the confined animal space, the remaining option is to remove these contaminants from the exhaust air. Among all air cleaning technologies, biotrickling filters are considered to be the next development for animal housing since they are easier to manage and are smaller in size compared to other exhaust air filtration technologies. Various configurations of biotrickling filters and bioscrubbers have been studied and showed a very good potential for controlling emissions from pig buildings. A number of operating conditions have been specified for biotrickling filters. Design values have been suggested for bed height, bed cross-sectional area, packing nominal size, empty bed residence time (EBRT), pressure drop, air temperature, liquid recycle rate, pH of the recycled liquid, and some typical control parameters. However, further work is needed in order to realize the best design that will perform effectively when installed in actual swine production facilities.

The main goal of this study was to develop an air cleaning technology that will reduce the offensiveness of the exhaust air from a swine grower-finisher facility. Initial phases of this project were conducted in collaborating research institutions in Quebec to design and develop the air treatment unit (ATU) and to determine their optimum operating parameters in laboratory scale tests. This part of the study conducted at PSC utilized the outcomes from the previous phases as basis for designing a commercial-scale ATU, which was evaluated in the PSC swine barn for its effectiveness in reducing ammonia, dust, and odour emissions.

“Air treatment units were effective in reducing the levels of ammonia, dust, and odour from grower-finishing rooms by about 77%, 92%, and 75%, respectively”

RESULTS AND DISCUSSION

Experimental set-up

Figure 1 shows the conceptual and actual experimental set-up for this study. Three identical air treatment units (ATUs) were installed outside of three grow-finish rooms at PSC barn; the exhaust air from each room was ducted to each ATU and passed through the biotrickling filter inside each unit. Monitoring equipment and sensors were installed in the rooms and in each unit to collect data on gas and dust levels, environmental parameters, as well as operational parameters such as airflow rates and water consumption. For this experiment, each individual unit was a replicate for two treatments (prior and after the ATU; non treated and treated air), hence, completion of this trial yielded 3 replicates.

Effect on ammonia concentration

Table 1 shows the weekly average ammonia (NH₃) concentration before (inside the room) and after each air treatment unit. Over the 12-week period, levels of ammonia inside the room ranged from 5.2 ppm to 69.1 ppm while the levels after the treatment units ranged from 4.0 ppm to 11.0 ppm. The difference in NH₃ levels before and after the unit was statistically significant ($p < 0.0001$) which means that the air filtration unit was able to significantly reduce levels of ammonia in the exhaust airstream before being released to the environment. It was also observed that the effectiveness of the ATU in reducing ammonia levels increased over time, i.e. on average,

from 22% reduction on week 1 to 77% on week 12. This implies that the air filtration units worked effectively even at the start of the trial; however, the reduction in NH₃ levels during the initial part of the trial was not that high because the incoming NH₃ levels were relatively low compared to the latter part of the trial when pigs were nearly market weights and NH₃ levels inside the room tended to be very high, thus, resulting to higher NH₃ reduction.

Effect on dust and odour concentration

Levels of total dust before and after the air treatment units are shown in Table 2. Significant reduction ($p < 0.0001$) in dust levels was observed after the exhaust air had passed through the treatment units. On average, dust concentration before the treatment units ranged from 0.255 mg/m³ to 1.301 mg/m³, which were reduced to about 0.089 mg/m³ – 0.266 mg/m³ after the units. Similar to ammonia, dust levels after the treatment units were not significantly different ($p = 0.183$) over the 7 monitored weeks; however, dust levels inside the rooms (before the units) increased significantly ($p < 0.0001$) with time. This has resulted to higher dust reduction achieved at the latter part of the trial when pigs were nearing market weights. Maximum dust reduction was about 92%, which was achieved on week 12 while the least reduction was about 65% during week 3.

The impact of the air treatment units on odour concentration was not as readily evident compared to ammonia and dust, though statistically significant reduction ($p = 0.017$) in overall odour levels was observed after passing through the treatment units. On average, odour concentration inside the room (before treatment) was about 815 ± 419 OU/m³ and was reduced to about 553 ± 208 OU/m³ after the air treatment units.

Water consumption

On average, the air treatment units consumed about 537.5 ± 113.3 liters of water per day; ATU 1 had the highest (663.0 L/day) while ATU 3 had the least (442.9 L/day). Wide variations in water consumption between ATUs can be attributed to the differences in frequency of replenishing the water in each particular unit, i.e., draining about 2 inches depth of water from the unit and then adding the same volume of fresh water, to maintain the water electrical conductivity below 7.5 μ S. Throughout the trial, the water in ATU 1 was replenished 16 times compared to 11 times for ATU 3; this could be related to NH₃ removal because as shown in Table 1, ATU 1 had the highest NH₃ removal efficiency while ATU 3 had the least. Periodically draining the contaminated water and then adding fresh water into the ATU was necessary to prevent the water from getting saturated, which consequently can adversely impact the biofilm activity on the biotrickling filter media, thereby reducing the contaminant removal efficiency of the system.

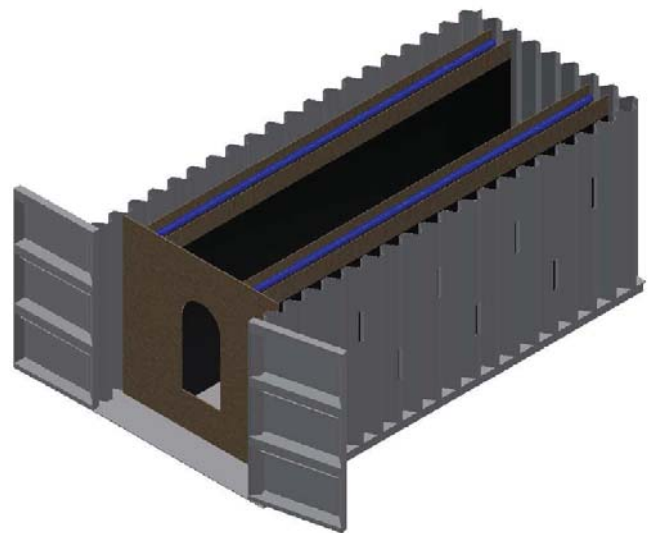

Figure 1. Conceptual diagram of the interior of each ATU



Figure 2. Actual installation of air cleaning unit at a grower finisher room

CONCLUSIONS

Based on the findings from this trial, the following conclusions can be made:

1. The biotrickling air treatment units installed at the exhaust of swine grow-finish rooms were effective in reducing the levels of ammonia, dust, and odour by about 77%, 92% and 75%, respectively.
2. The biotrickling units were able to reduce the levels of ammonia even at the initial stage of the trial, with the ammonia levels after the filter almost remaining the same throughout the trial. Hence, the percent reduction in ammonia increased as the initial ammonia concentration before the filter increased.
3. No clear diurnal pattern in ammonia reduction from the air treatment units was observed.
4. Water consumption tended to increase as the biotrickling units remove more contaminants from the air.
5. The biotrickling air treatment units had no adverse or beneficial impact on the performance of pigs in the room.

Table 1. Weekly concentration of ammonia (in ppm) before and after each ATU and the corresponding removal efficiency (RE).

Trial week #	ATU 1			ATU 2			ATU 3			Average		
	Before	After	RE (%)	Before	After	RE (%)	Before	After	RE (%)	Before	After	RE (%)
3	9.9	6.8	29.7	10.2	8.0	18.6	5.2	4.0	17.7	8.4	6.3	22.0
5	27.9	6.9	72.2	28.9	8.7	67.3	9.0	4.9	43.3	21.9	6.8	60.9
7	24.3	8.6	65.3	20.0	6.4	67.2	9.6	6.2	39.5	18.0	7.1	57.3
8	29.1	7.3	74.5	24.2	7.2	70.2	11.8	6.5	44.1	21.7	7.0	62.9
9	45.5	6.4	85.4	31.6	8.2	73.4	19.6	7.2	62.8	32.2	7.3	73.9
10	52.8	8.5	83.8	34.9	9.8	70.9	19.4	7.2	61.9	35.7	8.5	72.2
11	48.8	7.9	83.5	33.6	8.7	73.4	21.4	8.4	59.4	34.6	8.4	72.1
12	69.1	11.0	83.5	48.8	9.1	79.1	26.0	8.7	67.7	48.0	9.6	76.8
Ave	38.4	7.9	72.2	29.0	8.3	65.0	15.3	6.6	49.6			

Table 2. Levels of total dust (in mg/m³) measured inside the room (prior) and after each ATU and the corresponding removal efficiency (RE).

Trial week #	ATU 1			ATU 2			ATU 3			Average		
	Before	After	RE (%)	Before	After	RE (%)	Before	After	RE (%)	Before	After	RE (%)
3	0.039	0.034	12.8	0.115	0.060	47.4	0.612	0.172	71.9	0.255	0.089	65.2
5	0.341	0.046	86.4	0.314	0.119	62.1	0.764	0.260	66.0	0.473	0.142	70.0
7	0.504	0.052	89.7	0.681	0.181	73.4	1.160	0.175	84.9	0.781	0.136	82.6
9	0.568	0.320	43.7	0.909	0.157	82.7	1.572	0.322	79.5	1.016	0.266	73.8
10	1.067	0.245	77.1	1.086	0.298	72.6	1.477	0.234	84.2	1.210	0.259	78.6
11	1.075	0.018	98.3	1.222	0.222	81.8	1.605	0.491	69.4	1.301	0.244	81.2
12	1.005	0.092	90.9	1.039	0.173	83.3	1.729	0.039	97.7	1.258	0.101	91.9
Ave	0.657	0.115	71.3	0.767	0.173	71.9	1.274	0.242	79.1			

ACKNOWLEDGEMENTS

Strategic funding provided by the Saskatchewan Pork Development Board, Alberta Pork, Manitoba Pork Council and the Saskatchewan Ministry of Agriculture. The authors would like to acknowledge the Canadian Swine Research and Development Cluster (CSRDC) for the financial support to this research project.

Development of an Air Filtration System for Swine Transport Vehicles to Protect Against Airborne Diseases During Transport

B. Predicala, H. Bonifacio, S. Ekanayake, L. Whittington



Bernardo Predicala

SUMMARY

The overall goal of this project is to protect high-value pigs during transport using a trailer with an air filtration system. A comprehensive literature search and a survey of various information sources on trailer filtration were conducted to identify components of a trailer air filtration system and the various options available for each component. Using a set of relevant design criteria, the different options were evaluated to select the components included in the prototype design. Presently, the proper components are being assembled for retrofit into the prototype trailer. Remaining steps to complete the project include prototype testing, design optimization, and feasibility analysis.

“Risk of infection of the breeding stock during transport can be significant, particularly during passage through pig dense areas”

INTRODUCTION

The growth and success of the Canadian pork industry over the past decades depended significantly on access to highly improved genetics. Transporting breeding stock is a daily occurrence across Canada, and individual farms have biosecurity procedures to reduce the potential for disease outbreaks. However, the risk of infection of the breeding stock during transport can be significant, particularly during passage through pig dense areas, where disease outbreaks can still happen despite current biosecurity protocols in place. Thus, it is imperative that measures be developed to protect breeding stock during transport, thereby avoiding infection of these high-value animals and the consequent significant economic loss, and more importantly, to close this biosecurity gap through which potential infection can be introduced to high-health commercial herds. The overall goal of this work is to design, develop, and



Canadian Swine Health Board
Conseil canadien de la santé porcine

evaluate an air filtration system that can be fitted to a transport vehicle to prevent infection of the high-value breeding stock during transport.

RESULTS AND DISCUSSION

In this project, an air filtration system was designed and developed to filter the air entering an animal transport trailer, to protect high-value animals from infection with airborne transmissible diseases during transport. A literature review supplemented with a survey of relevant resources (i.e., veterinarians, truckers, genetics companies, etc.) was conducted to compile information on existing and potential designs for an air filtration system for transport vehicles, followed by selection of best design based on comprehensive evaluation of various options available for each component of the filtration system.

Information on designs of air filtration systems of existing filtered animal transport vehicles was gathered from literature and by contacting and interviewing different contact persons and organizations with filtered trucks/trailers. Organizations based in Europe (France, Netherlands) and USA were interviewed, which belonged to the following categories: swine genetics company; swine technical support/consulting firm/swine research; swine transport service and swine/livestock trailer/truck manufacturer.

The length of the filtered trailers from these organizations varied from 20 to 53 ft. The trailer/truck manufacturer based in Netherlands has multi-deck filtered trailers, which were used for transporting smaller pigs (e.g., 23-kg pig); the rest has one-deck filtered trailers. Unfortunately, only the general design of its air filtration system was described and shared by the company. From the literature search and survey results, the critical factors that need to be considered in the design of the ventilation and air filtration system for the trailer were identified as: 1. *animal spacing requirement and trailer capacity*, 2. *pig heat generation and equivalent air conditioning requirement*, 3. *ventilation requirement as a function of air temperature inside the trailer and pig size*, 4. *available filter technology*; and 5. *power supply needed to run the whole system*.

The major parts of a trailer filtration system were components for: 1. temperature control, 2. filtration, 3. ventilation, and 4. air distribution. Additionally, there are secondary components of the system that were identified; these include components for: 1. air exhaust, 2. emergency openings, 3. parameter monitoring, 4. cleaning and disinfection, and 5. bedding and watering supply.

Based on the designs of the surveyed trailers, the type of fans commonly used in these filtered trailers were axial fans. High efficiency particulate air (HEPA) filters and Di-octyl Phthalate (DOP)-tested filters were the type of filters installed in these filtered transport vehicles, with five currently using HEPA filters. Typical source of power needed to operate the fans was the diesel-type generator.

After gathering all the available information on trailer components and the associated options for each component, the specific option that will be included in the design of the prototype system was selected by having each project team member evaluate the different options according to the following criteria: 1. robustness, 2. impact on trailer environment (air quality, air flow, thermal environment), 3. power requirement, and 4. costs. The project team evaluated each option and based on the ratings, the design of the air filtration system for the prototype trailer includes the following major components: 1. non-airconditioned, 2. MERV filters, 3. axial fans, and 4. no air diffuser.

In the current phase of the project, the required components of the trailer filtration system will be gathered and installed on the trailer. Ventilation system of the prototype design will consist of high performance axial fans to overcome pressure drop across the filtration system. Incoming air will be filtered in a sealed chamber operating under negative pressure, and the filtered air will be distributed to the trailer decks. Air filtration will consist of minimum efficiency reporting value (MERV) 14 and MERV 16 air filters (90 - 95 % composite average particle size arrestance efficiency) and

high efficiency particulate air (HEPA) filters. Calculation of stocking density per deck, ventilation rate per deck, air velocity per deck, heat generation by pig per deck, and expected air temperature inside the trailer were done according to applicable recommended guidelines for Canadian conditions.

CONCLUSIONS

Comprehensive literature search and survey of different information sources on trailer filtration were conducted to identify the major trailer filtration components and the various options for each component. Based on evaluation of the different options, the components included in the prototype design of the air filtration system that will be fitted to a swine transport trailer were selected. The prototype system will be installed in an actual livestock trailer and will be tested for effectiveness in preventing airborne-transmitted pathogens transmission during transport, and in providing suitable thermal environment to the animals under Canadian conditions. Finally, after re-design and optimization steps, a feasibility analysis will be conducted to assess the viability of installing air filtration systems on swine transport trailers.

ACKNOWLEDGEMENTS

The authors would like to acknowledge the Canadian Swine Health Board and the Canadian Agricultural Adaptation Program for the financial support to this research project. The authors also acknowledge the strategic funding provided by Sask Pork, Alberta Pork, Manitoba Pork Council and the Saskatchewan Ministry of Agriculture to Prairie Swine Centre Inc.



Temperament Traits Related to Stress and Meat Quality: Are they Reliable and Heritable?

J.A. Brown, Y.M. Seddon, F.C. Rioja-Lang and H.W. Gonyou



Jennifer Brown



Harold Gonyou

SUMMARY

This project evaluated different behavioural tests for their ability to accurately determine temperament traits related to the stress response of pigs, and determine: a) whether these traits are consistent within individual pigs over time, and b) if they are heritable. Results found evidence that supports the use of simple behavioural tests to distinguish between temperament traits in pigs.

Correlations between the behavioural responses of gilts measured at two different time points (12 and 18 weeks of age) were evident in both the 1st generation and in 2nd generation offspring, indicating consistency of these traits within individual pigs over time. Temperament classifications of individual pigs were also correlated to the concentration of saliva cortisol following handling and following mixing in 1st generation gilts. The analysis of temperament heritability is ongoing, with the initial results suggesting that pigs could be selected for reduced stress response. Further studies with larger numbers of animals would be needed to determine the full merit of these tests as a selection tool.

INTRODUCTION

The susceptibility of pigs to stress can significantly influence their welfare, and in turn can also affect their productivity, ease of handling and stockperson labour required when working with them. The stress caused during transport and handling of pigs at marketing can result in severe losses for both producers and packers, resulting in in-transit death losses, carcass damage and reduced meat quality (eg. increased incidence of PSE pork).

Individual differences are known to exist in pigs, with these differences in temperament being shown to significantly affect the way pigs handle stressful situations and their subsequent meat quality. The heritability of temperament traits is believed to exist

in pigs, however the level of heritability found by studies has been shown to vary from moderate to weak. If future breeding stock could be selected on the basis of temperament tests and their relation to stress response, it would be possible to select over time for reduced levels of stress in both parents and offspring.

The overall objective of this work was to assess the temperament of pigs using practical, on-farm behavioural tests and to establish links between temperament classification, stress response and the subsequent heritability of behavioural traits. To achieve this goal, we conducted a thorough evaluation of four tests for assessing pig temperament that can be applied on commercial farms.

This evaluation included an assessment of:

- i) The reliability of each test (consistency over time)
- ii) The relationship between temperament (as indicated by behavioural tests) and the stress physiology of pigs in response to handling, and
- iii) The heritability of temperament traits (ie. do they respond to selection?).

“Stress caused during transport and handling of pigs at marketing can result in severe losses for both producers and packers”

EXPERIMENTAL PROCEDURE

The study was conducted in two phases and used a total of 521 animals.

Phase I.

Testing and selection of 1st generation gilts for breeding.

Behavioural testing: Over a 16 month period, a total of 276 gilts were evaluated in behavioural and physiological tests at 12 and 18 weeks of age. Four behavioural tests were used to assess the temperament of gilts. A brief description of the tests is as follows:

The open-door test (ODT): Four to six pigs were placed in a pen, and given 5 minutes to acclimatise. The pen door is opened and the latency for each pig to exit the pen recorded, to a maximum of three mins. Pigs that rapidly exit the pen can be described as ‘active’, while those that are reluctant to exit are ‘passive’ (Figure 1).

Human approaching pig test (HAP): One pig was placed in a test pen. A human entered the pen and approached the pig slowly (Figure 2). An observer scored the response on a scale of 1–4 relating to how the pig responded. For example: 1= pig appears fearful, moves away rapidly or 4= pig not fearful, interacts with human. Pigs with a high HAP score (e.g. 4) can be described as ‘confident’, while those with a low score (e.g. 1) are ‘fearful’.

Pig approaching human test (PAH): One pig was placed in a test pen. A human entered the test pen and stood in a predetermined location. For up to a maximum of three minutes, the latency of the pig to make contact with the human, the number of contacts made, and the duration of time spent within one meter of the human was recorded. Pigs with a shorter latency to contact the human are described as ‘confident’, while those with a longer latency, or no contact at all are described as ‘fearful’.

The novel object test (NOT): One pig was moved into a test pen with three objects (Figure 3). One observer outside the pen recorded the latency for pigs to make contact with the first object, the number and duration of contacts with each object, and the number of times the pig switched between objects. Pigs that were quick to make contact and switched objects frequently are described as ‘active’, while pigs that were slower to contact the objects, but spent more time exploring each object are described as ‘passive.’

Eighty-one gilts which showed extremes of behavioural response in tests, i.e. in active/passive and confident/fearful phenotypes, were selected (forming the 1st generation) for breeding and heritability studies. The response of the bred gilts to mixing was evaluated during gestation.

Physiological testing: Following behavioural tests at 18 weeks of age, the 81 selected gilts were subjected to a standardized handling test to evaluate their physiological response to a stressor. The handling test involved walking a pig around the corridor of the room for a distance of 100m. The total time taken, the handling responses of the pig (balks, attempts to turn back, vocalizations), and the actions required by the handler to keep the pig moving were recorded. Prior to the test gilts were fitted with heart rate monitors and salivary cortisol samples were collected using cotton swabs before handling and at 10 and 40 minutes after the handling stressor.

Phase II.

Heritability of Temperament

Progeny of the 81 selected 1st generation gilts were reared under standard management conditions. A total of 250 gilts (three from each litter, forming the 2nd generation), were reared to market weight and subjected to the same behavioural testing at 12 and 18 weeks of age. Similar to their dams, the progeny were also tested with the standardized handling protocol at 18 weeks of age.



Figure 1. Sow exiting the pen in the open door test.

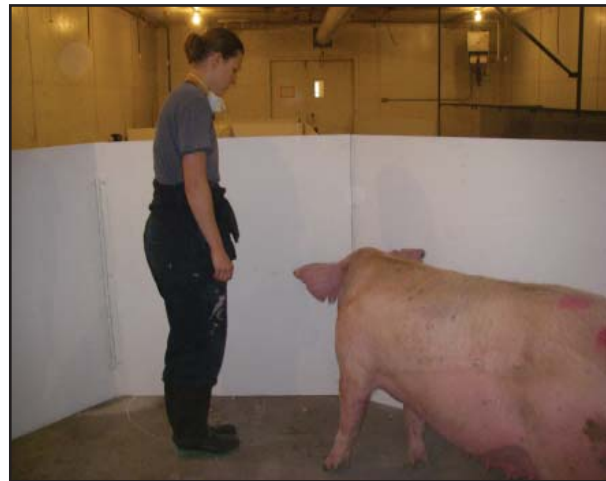

Figure 2. The human approaching pig test.

RESULTS AND DISCUSSION

Correlations between temperament tests:

Within each generation of pigs tested, significant correlations were found between responses to the HAP, PAH and NOT tests at 12 and 18 weeks of age however, there were not any correlations between ODT measures. The positive correlation of behavioural responses to tests conducted at two time points provides evidence that the tests measure traits that are consistent within individuals over time, and demonstrates the validity of these tests as a measure of temperament (personality). The HAP and PAH are considered as tests related to confidence and fear in pigs, especially in relation to human interaction. Fear related to humans is arguably the most relevant stressor in swine production. The NOT measures the pigs’ innate exploratory response to a novel object, and is considered a measure of active/passive traits. The failure of the ODT to show significant correlations over time may relate to problems with the test procedure or changes in the response of pigs over time as they mature.

Temperament classification:

Factor analysis of the behavioural responses in each of the temperament tests was performed, and confirmed that HAP and

PAH tests assess traits related to confidence and fearfulness, and that ODT and NOT tests assess active and passive traits. Based on their response to the tests, each pig was assigned a score weighing their temperament for active/passive and confident/fearful dimensions.

Relationships between pig behavioural response to handling and stress response:

Within the 1st generation, there were no correlations between the saliva cortisol measures taken before and after handling and the behavioural response of the pigs to handling. The lack of significant relationships could be due to the smaller number of pigs studied for this generation, and there were also several missed measures which hindered our ability to determine significant relationships. In the 2nd generation there was a greater number of pigs studied. Here the total number of aversions (balks and turn backs) displayed during handling was positively correlated to the average and maximum heart rate, and to the average concentration of cortisol measured 40 minutes after handling. Together, these results indicate that the more aversions displayed by a pig, the greater the stress experienced, as indicated by elevated heart rate and cortisol concentration. The relationships between the pig's behavioural response to handling and physiological measures of stress suggest a causal relationship. Elevated heart rate in response to handling, indicates arousal of the sympathetic nervous system (stress response), and elevated concentrations of cortisol following handling has been found to be related to negative handling experiences.

Relationships between temperament and stress response in 1st generation gilts:

In the 1st generation gilts, the average cortisol concentration measured 40 minutes after handling was negatively correlated to the active/passive temperament scores, as determined from tests at 18 weeks of age, indicating, that pigs with more active temperament traits had higher levels of cortisol following handling. Similarly, a positive correlation was found between the change in salivary cortisol concentration from samples taken before and after handling, and the active/passive temperament scores determined from tests at 18 weeks, with this result also suggesting a larger change in cortisol in pigs with active temperament traits.

Differences in the endocrine stress response in relation to different temperament coping styles have been explored previously, and it has been found that pigs described as having an active coping style have a lower HPA activity, including lower cortisol responses, than pigs classed as passive, however this differs from the relationship found in this study. The difference in findings may be linked to differences between basal concentrations in cortisol, and cortisol released in response to a stressor.



Figure 3. Novel objects presented in the novel object test. .

Calm/fearful temperament scores at 12 weeks of age were negatively related to the concentration of salivary cortisol measures taken 72 hours after mixing. In addition, the calm/fearful temperament scores at both 12 and 18 weeks of age were positively correlated to the change in cortisol concentration from pre- to post-mixing. This indicates that pigs with fearful temperament traits (lower scores) had a greater increase in cortisol concentration at mixing.

Analysis to determine the temperament scores for the 2nd generation gilts is in progress, and will help to confirm the association between stress responses and pig temperament. The analysis of heritability between 1st and 2nd generations is ongoing.

CONCLUSIONS

The results of this study are preliminary, but offer evidence to support the occurrence of distinct temperament traits in pigs and the relationship between temperament and the stress response. The results also indicate that tests measuring pigs' response to humans (HAP and PAH tests) provided the most accurate assessment of the fear response, while the ODT and NOT appear to measure different responses related to active/passive traits. The results of this study are encouraging, and suggest that pigs could be selected for reduced stress response on the basis of temperament tests. Further analysis is needed to better identify and distinguish the traits associated with these tests and interactions with previous experience. For the future, a larger study, ideally with the inclusion of additional stress testing and meat quality analysis would be beneficial to determine the full merit of these tests as selection tools for improved pork production.

ACKNOWLEDGEMENTS

The authors gratefully acknowledge specific project funding for this study provided by the Alberta Livestock Meat Agency (ALMA) and Sask Pork. Strategic program funding to the Prairie Swine Centre was provided by Sask Pork, Alberta Pork, Manitoba Pork Council, and the Saskatchewan Agricultural Development Fund.

Investigation of Translactational Analgesia for Reducing Piglet Pain at Castration

Y.M. Seddon, J. Stookey, J. Alcorn, M. Bouvier and J.A. Brown



Jennifer Brown



Yolande Seddon

SUMMARY

Public concern regarding painful livestock procedures such as castration is increasing. Piglet castration has been criticized, largely because pain medication is not commonly used. The cost and time required to administer analgesics to individual piglets are the main deterrents to the swine industry adopting this practice. Having an affordable and practical method of delivering pain relief would likely increase the use of pain medication by producers, and increase the acceptance of this procedure.

The objective of this study was to determine if pain medication can be transferred to the piglet through the sow's milk, and if so, to determine how effective this technique is for reducing acute pain at the time of castration, and for reducing pain and inflammation after surgery. A novel technique for measuring pain in piglets using a handling chute was also developed.

Results showed that the transfer of the analgesic, Metacam®, to piglets via the sow's milk was not effective, as the maximum concentration of analgesic in piglet blood (up to 5 hours after injection of the sow) was less than 1/200th of that found in sow's blood, and 1/80th of that found in milk. Thus, the concentration of analgesic transferred to piglets via milk was too low to provide effective pain relief. Modification of the drug could result in increased transfer to piglets. Work is ongoing to validate the use of the handling chute for measurement of castration pain in piglets.

INTRODUCTION

Concerns regarding painful procedures in livestock production are increasing, with the castration of piglets being one of the key issues related to pig production. Castration of male piglets is done to avoid 'boar taint', the development of undesirable odours which can occur in the meat of adult boars. The main concern related to piglet castration is that it is typically done without the use of analgesics.

The cost and time required to administer a pain medication to individual piglets reduces its adoption by producers. It is estimated to cost the Canadian industry \$2 million on an annual basis. However, if an affordable and practical method of delivering pain control were available, its use would likely increase. Studies with cattle have found that pain medication can be transferred through the milk at lactation. However, there is a lack of research in this area in pigs and no knowledge of the extent of passive drug transfer to offspring through the milk. This study examined analgesic drug levels in paired samples of sow blood and milk, and the amount of drug transferred to piglets through the consumption of milk.

Work was also done to develop a novel behavioural test to assess pain in piglets, as currently our ability to assess pain responses in young piglets is very limited. Previous studies have shown there is little difference in the behaviour of castrated and non-castrated piglets after castration, as piglets generally continue to feed and rest with their littermates following the procedure, with only minor changes in posture and movement. However, physiological research has demonstrated that piglets do experience pain following castration, and refining behavioural methods for pain assessment are needed as such tests will aid in the development and refinement of pain control techniques. The pain assessment research is ongoing, and will be completed in late 2013.

“Cost and time required to administer analgesics to individual piglets are the main deterrents to the swine industry adopting this practice”

EXPERIMENTAL PROCEDURES

The first objective of this project was to determine the levels of pain medication (Metacam®) that are excreted via the milk, and to compare concentrations of the drug in sows' blood and milk over a five hour period. The second objective was to determine the amount of drug transferred to piglets via the sow's milk, and to identify the optimum time period that will provide the maximum transfer of drug to piglets. A final objective of the study is to evaluate the use of a handling chute with hurdles for assessing piglet pain responses following castration.

Table 1. Average Metacam® concentrations in milk over a 5 hour period in experiment two.

Time post injection (m)	Mean calculated conc.(ng/mL)	Standard deviation
60	148.67	11.33
180	188.33	80.03
300	139.03	84.11

MATERIALS AND METHODS

Our first experiment studied the transfer and excretion of analgesic in milk. Twelve sows were injected with Metacam® at seven days post-farrowing, with each sow receiving one of three dosages (0.50, 0.75, or 1.00 mg/kg). After the injection, eight blood samples were collected from each sow using an ear vein jugular catheter over a five hour period to determine the kinetics of absorption and distribution. Three milk samples were collected from each sow at approximately 1, 3 and 5 hours following injection. Methods for analyzing the drug concentration in blood and milk by high performance liquid chromatography (HPLC) were developed and validated at the University of Saskatchewan.

In the second experiment, examining drug transfer to piglets, we injected sows with Metacam® and then collected blood samples from two male piglets per litter to determine the levels of analgesic that are transferred to piglets through the sow's milk. A third experiment to assess whether translactational analgesia is effective at reducing pain was initially planned, but was not performed due to the low levels of drug found in piglets.

A further study is now underway to assess the pain responses of piglets to castration, comparing piglets given pain relief via an

injection of Metacam® prior to castration, with sham castrated piglets (handled for castration, but not castrated). Metacam® is a non-steroidal anti-inflammatory (NSAID) drug, similar to aspirin, and is expected to reduce pain and inflammation following castration. However it not likely to have a significant effect on acute pain experienced at the time of castration.

As a method to more clearly identify pain responses following castration, we have developed a chute with hurdles which piglets are placed at different time intervals following castration. The chute will help assess piglet pain responses on the assumption that piglets will take longer to travel down the chute and over two hurdles (requiring lifting of the rear legs), if they are experiencing pain. The stride length of the rear legs will also be measured as the piglets traverse the chute by painting the piglet's feet with ink and recording stride length. Other measures will also be used to assess pain, including monitoring behaviour following castration (lying, standing, time spent suckling).

RESULTS AND DISCUSSION

Metacam® concentrations in blood peaked between one and two hours after injection, with peak concentrations of approximately 450 ± 200 ng/ml. Concentrations in milk were greatest at three hours after injection, with peak concentrations of approximately 200 ± 100 ng/ml following injection of 1 mg/kg Metacam. A high degree of variation was found in the drug concentrations in blood and milk samples from different sows.

Drug transfer to piglets

In the second study, analgesic concentrations in the sows' milk were found to follow a similar pattern to those observed in the first study. Average Metacam® concentrations in milk at 1, 3 and 5 hours following injection are shown in Table 1. Analgesic concentrations in

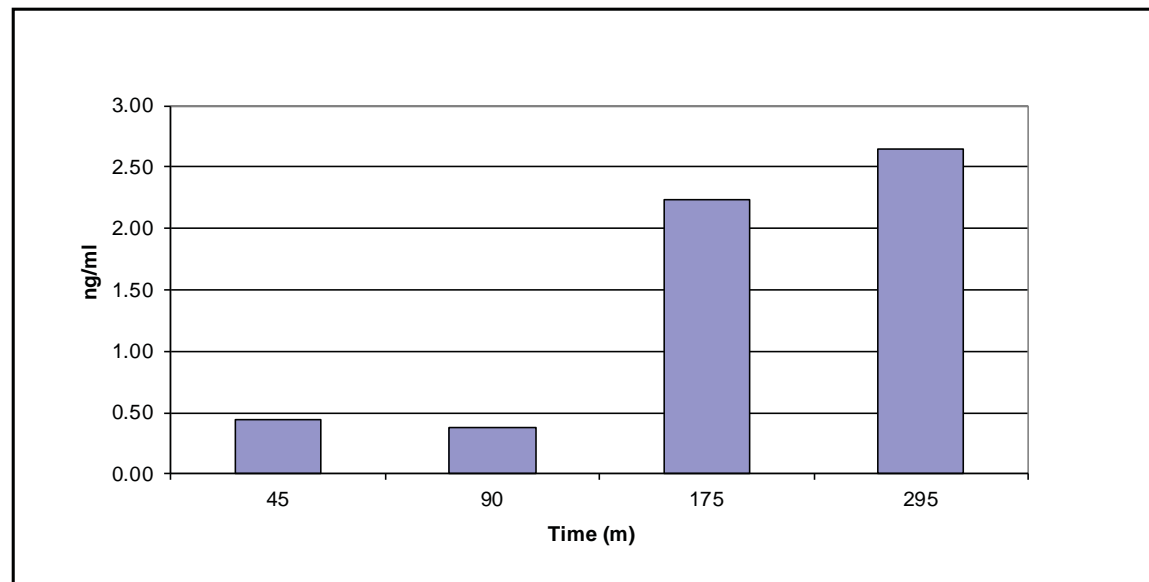

Figure 1. Average Metacam® concentrations in piglet blood serum over time..

the sow's milk peaked at 3 hours post injection at 188 ng/ml, similar to the level observed in the first study at the same drug dosage. Average analgesic concentrations found in piglet blood in the 5 hours following injection of the sow are shown in Figure 1. Drug levels were found to increase significantly over time, with a peak concentration of approximately 2.5 ng/ml at 295 minutes post-injection, and the largest increase being between 90 to 175 minutes post-injection. A drop in analgesic concentration was not observed over the five hour sampling period, and therefore the peak analgesic concentration achieved over time is unknown.

The low levels of Metacam® detected in piglet serum are not promising in terms of the potential for this technique to offer pain relief. For example, sows given 1 mg/kg in the second experiment achieved drug levels in serum up to 470 ng/mL, and is approximately 150 times higher than levels found in piglet serum. In order for this technique to be successful, it may be necessary to modify the active drug to promote excretion via the milk.

Assessing pain responses in piglets

A chute was developed which can be installed behind the farrowing crate, and allows piglets to move down a 1 m corridor to return to the sow and her litter (see Figure 2). Piglets were trained to negotiate the chute on the day before castration, and then on the day of testing, the responses of castrated and non-castrated piglets in the chute were compared. Initial results suggest that at 20 minutes after castration, castrated piglets were slower to move down the chute than non-castrated controls. Additional validation work on use of the handling chute for pain assessment in piglets is being performed currently, with completion in September 2013.



Figure 2. Piglet moving through the handling chute.

CONCLUSIONS

With growing awareness of animal welfare issues in the retail market, practical and economic methods for pain mediation are needed for producers to meet increasing animal welfare standards. Directly injecting analgesics into piglets involves drug administration and extra handling time. If effective, translactational medication could reduce the handling time involved and stress on piglets. Unfortunately the initial results presented here indicate that the level of Metacam® transferred to piglets in milk is less than 1% of that in sow blood and is not likely to reduce pain following castration. A modified drug, or other analgesics (e.g. Ketoprofen®), may be more effective at delivering pain relief with this technique.

Further trials are in progress to evaluate the use of a handling chute for assessing piglet pain. If successful, the device will be a useful tool for evaluating and comparing techniques for providing pain relief at castration.

ACKNOWLEDGEMENTS

Strategic program funding for this research was provided by Sask Pork, Alberta Pork, Manitoba PorkCouncil, and the Saskatchewan Agricultural Development Fund. Specific project funding was provided by the US National Pork Board.

Early Detection and Interventions for Reducing Lameness in Gestating Sows

Y.M. Seddon, F.C. Rioja-Lang, and J.A. Brown



Yolande Seddon



Jennifer Brown

SUMMARY

Lameness in sows is a painful condition that can affect fertility, mobility, feed intake and culling rate. Methods for the early detection and prevention of lameness have not been studied extensively, but if effective, such measures could improve overall herd health, welfare and the productivity of sows. Poor hoof condition is increasingly believed to be a contributing factor to lameness development.

The objective of this study was to, i) conduct a survey to assess the prevalence of lameness and hoof condition in a large commercial sow herd, ii) assess the effectiveness of preventative hoof trimming on reducing the occurrence and severity of lameness, and iii) assess the effectiveness of an early intervention treatment, including analgesics, provision of rubber stall matting to aid recovery and a corrective hoof trim, at reducing the prevalence and severity of lameness.

Results to date show that from a survey of 3,286 sows (55% of the herd), almost 60% of sows showed signs of lameness in at least one leg, and a large percentage of sows had multiple hoof lesions. Although the completion of objectives ii and iii is ongoing, preliminary data suggest that preventative hoof trimming reduces the occurrence and severity of lameness in gestation. The results so far indicate that true prevalence of lameness on farms is likely to be underestimated.

INTRODUCTION

Lameness is a common problem among sows and is believed to be one of the most common reasons for culling. Prevention and treatment of lameness is of great importance for sow welfare, productivity and overall herd profitability, sows need to remain in the herd for at least three parities before generating a profit, and

“Preliminary data suggest that preventative hoof trimming reduces the occurrence and severity of lameness”

therefore premature culling of sows results in financial loss. As well, as producers shift to group housing systems, sow mobility will become more important and having options for prevention and treatment of lameness will be of increased benefit to producers. Methods for the early detection and prevention of lameness in sows have not been studied extensively, but would have the potential to reduce veterinary and euthanasia costs and to improve the productivity and profitability of pork production. Increasingly, along with joint issues, there is evidence suggesting that hoof condition contributes significantly to the development of lameness in sows and gilts. Currently, there is a lack of knowledge of techniques to prevent or treat lameness. Hoof trimming is commonly used to maintain hoof condition in many hooved species, including dairy cattle, sheep and horses, however it is not commonly performed in pigs. This study examined the role that corrective hoof trimming has on foot health and lameness using the Feet First® chute. The chute was recently developed by Zinpro Corporation (Minnesota,

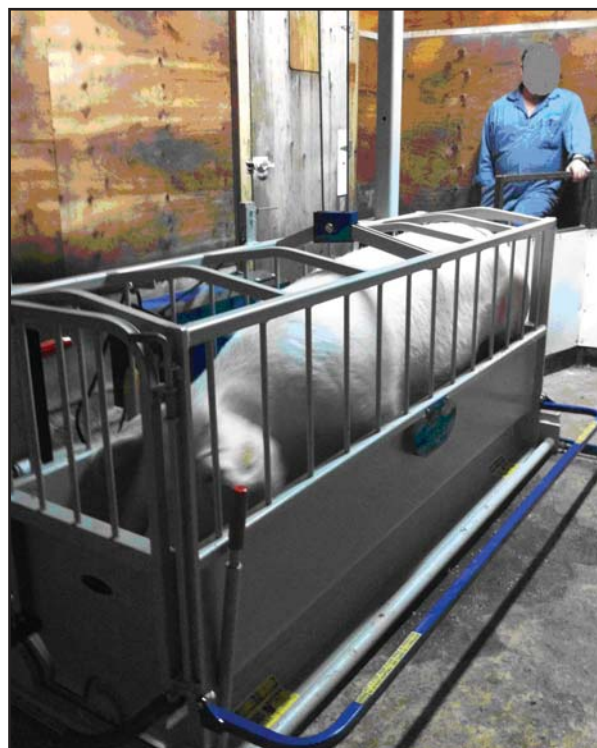

Figure 1. The Zinpro FeetFirst© chute.

USA), and is designed to safely restrain and lift a sow, allowing examination of the sow's hooves and completion of a corrective hoof trim. This study used the FeetFirst® chute, and is the first examination of its use in a Canadian swine herd.

EXPERIMENTAL PROCEDURES

A 6,000 sow commercial operation was recruited to participate in the study, with the aim of observing incidences of lameness more representative of commercial production than is found in the Prairie Swine Centre's 300 sow research herd. Sows were stall housed for the duration of gestation.

Objective one: Survey of prevalence, type and severity of lameness

At four weeks gestation, sows were removed from their gestation stalls and lameness was assessed as sows walked on a solid concrete hallway. A trained technician observed the sows as they walked a distance of 20ft, and sows were given a locomotion score in accordance with the Zinpro Feet First© scoring system, as follows:

- 0: Sow moves easily with very little inducement. She is comfortable on all four feet.
- 1: Sow moves relatively easily but visible signs of lameness are apparent in at least one leg although it may be difficult to determine which leg is causing the lameness.
- 2: An abnormal gait is observed. Lameness could be observed in one or more limbs. The sows may exhibit compensatory behaviours such as dipping and raising her head in time to foot falls and arching her back.
- 3: An abnormal gait is observed and the affected limb(s) are able to be identified. The sow may be reluctant to bear weight on the affected limb and will avoid using it. Sow will be reluctant to move, and it is difficult to move her from place to place in the barn.

Following the locomotion observation, each sow received a hoof assessment on all four feet. Each hoof was assessed for hoof wall cracks (both vertical and horizontal), toe length, dewclaw length, heel overgrowth and white line cracks. Hooves were scored for each lesion on a scale of 0-3 in accordance with Zinpro's hoof lesion scoring guide (Table 1). A healthy hoof with no sign of lesions was given a score of zero. Any injuries observed (e.g. open wounds, bruising, joint swelling) were also recorded. The parity of each sow was recorded, and a number of the sows were then selected for objectives two and three of the study.

Objective two: Preventative Hoof Trimming

A total of 200 non-lame sows (locomotion score 0, as determined in phase one) were allocated to either a treatment group (received a hoof trim at eight weeks gestation), or a control group (received no treatment, observed only), with 100 sows per group. In addition to the locomotion and hoof lesion scores collected in phase one at four weeks gestation, all sows received a hoof examination at eight weeks gestation using the Zinpro FeetFirst© chute (Fig. 1). Sows were restrained in the chute and raised off the ground to allow a detailed examination of all four feet. Sows allocated to the treatment group received a corrective hoof trim (Fig. 2), while those allocated to the control group did not. The goal of the hoof trimming was to restore good conformation to the hoof and to correct the weight distribution and balance. The hoof trimming procedure followed was developed by Zinpro, and conducted as follows:

Step 1. Reduce toe length: Using nippers, make the toe length of both claws as equal in length as possible. A hand grinder is used to smooth any sharp edges.

Step 2. Straighten the hoof wall: If the toe has any curve to it, remove excess wall growth and straighten the hoof wall.

Step 3. Balance the hoof: Balance the sole and the heel of the foot using the grinder on the bottom of the foot to restore normal weight bearing. Any excess heel growth is removed.

Table 1. Zinpro FeetFirst© hoof lesion scoring guide.

Lesion description	Toes (T)	Dew Claws (DC)	White Line (WL)	Heel overgrowth and erosion (HOE)	Cracked wall (CW)
1	One or more toes slightly longer than normal	Slightly longer than normal	Shallow and/or short separation along white line	Slight overgrowth and/or erosion in soft heel tissue	Haemorrhage evident, short/shallow crack in wall.
2	One or more toes significantly longer than normal	Claws extend to floor surface when the pig is standing	Long separation along white line	Numerous cracks with obvious overgrowth and erosion	Long but shallow crack in wall
3	Long toes that affect gait when walking	Claw is torn and/or partially or completely missing	Long and deep separation along white line	Large amount of erosion and overgrowth with cracks throughout	Multiple or deep cracks in the wall.



Figure 2. Performing a hoof trim on a sow with use of a hand grinder.

Step 4. Trim the dew claws: Overgrown dew claws should be shortened removing the hoof in gradual steps. A grinder was then used to round off and remove any sharp edges.

All sows were given a second locomotion score at 13 weeks gestation to observe any changes. Following gestation, standard production measures were collected per sow, including the number of piglets born, live born, stillborn, mummified and weaned.

Objective three: Lameness intervention

Objective three of the study investigated the effectiveness of early intervention (treatment) for lame sows. Two-hundred lame sows (locomotion score 1-3) were randomly assigned to one of the following:

- 1) Early Intervention: Hoof evaluation and trimming, housed on rubber flooring, and administered 2 NSAID injections (n=100)
- 2) Control Treatment: Hoof evaluation, housed on concrete flooring (n=100)

An additional control group of non-lame sows (given a '0' in the lameness assessment) were also monitored (n=100) for comparison purposes. The data collection for this phase is still ongoing.

RESULTS AND DISCUSSION

Objective one - Sow lameness survey

A total of 3,286 sows (55% of the total sow herd) were assessed for locomotion and hoof lesions. Of the sows surveyed, 40.9% were not lame, 53.2% were mildly lame (a score of 1), 5.7% moderately lame (a score of 2), and 0.2% severely lame (a score of 3), (Figure 3). Together these results indicate that almost 60% of the herd show signs of lameness in at least one leg, which is considerably higher than has been reported in literature. Although this study has found an elevated incidence of lameness, there were very few severely lame animals, with only 0.2% (7 sows) having a locomotion score of 3. The number of sows scoring 1 was very high, however, at this level of lameness the majority of cases may go largely unnoticed by stockpersons, as it can be slight and difficult to pinpoint. The mild nature of early lameness thus contributes to the general underreporting of the problem. Examining parity differences, between 42 and 59% of sows in parities 0-3, were found to be lame. This illustrates a significant problem, and risk, if young parity sows are showing lameness and may be prematurely lost from the herd due to lameness. Thus identifying effective treatments that can be implemented at this early stage may have a significant impact.

Concerning the condition and health of the hooves, 80% of sows had a correct toe length, with a score of 0. Long dew claws were prevalent in 67% of sows, and 52% of sows had heel erosion. Wall and white line cracks were less prevalent with 26% and 36% of sows affected, respectively. There was significant missing data related to heel erosions and white line scores in this phase of the study due to sows being assessed while standing, making it difficult to observe the underside of the hoof, thus these results may not be representative. It is likely that a higher prevalence of these conditions exists than is reported here. The quality of flooring is believed to be strongly linked to the prevalence of foot lesions.

Objective two - Preventative hoof trimming:

Preliminary results suggest that when comparing the control and treatment groups at week 13 of gestation (five weeks after hoof trimming for treatment sows) a greater number of the hoof trimmed sows remained sound (locomotion score of 0), and fewer sows showed increased lameness, compared to sows in the control group (Figures 4 and 5). These preliminary results, comparing trimmed and untrimmed sows, suggest that trimming may be beneficial for preventing the further development of lameness, and for reducing the severity of lameness that does develop. Data collection is nearing completion for this phase of the trial, and a full analysis is needed before firm conclusions can be drawn. The final analysis will also consider the extent to which hoof lesions are related to lameness.

CONCLUSIONS

This study provides detailed results on the prevalence of lameness in a large commercial sow herd. The preliminary results indicate that the prevalence of lameness on the study farm is high, with roughly 50% of low parity sows being affected. Observations of hoof condition indicate that hoof lesions, long dew claws and heel erosion are the most common problems. Previous research indicates that hoof lesions are related to the partially slatted concrete floors that sows are housed on. The sows in this study were housed in gestation stalls, and in this setting mild lameness may be largely unnoticed. As producers move to group housing systems for sows, the effects of lameness may be more easily observed,

and thus further work to improve management of sows (good nutrition, genetics, flooring and hoof care) to reduce lameness will be of increasing importance to the swine industry. Corrective hoof trimming may be one option to help farms manage and reduce lameness, with the initial results here suggesting that hoof trimming can reduce the development of lameness.

ACKNOWLEDGEMENTS

The authors gratefully acknowledge specific project funding for this study provided by Agriculture and Agri-Food Canada's Canadian Agricultural Adaptation Program, which is managed in Alberta by the Agriculture and Food Council of Alberta. We thank Zinpro Corporation for providing materials and training for this research. Strategic program funding to the Prairie Swine Centre was provided by Sask Pork, Alberta Pork, Manitoba Pork Council, and the Saskatchewan Agricultural Development Fund.

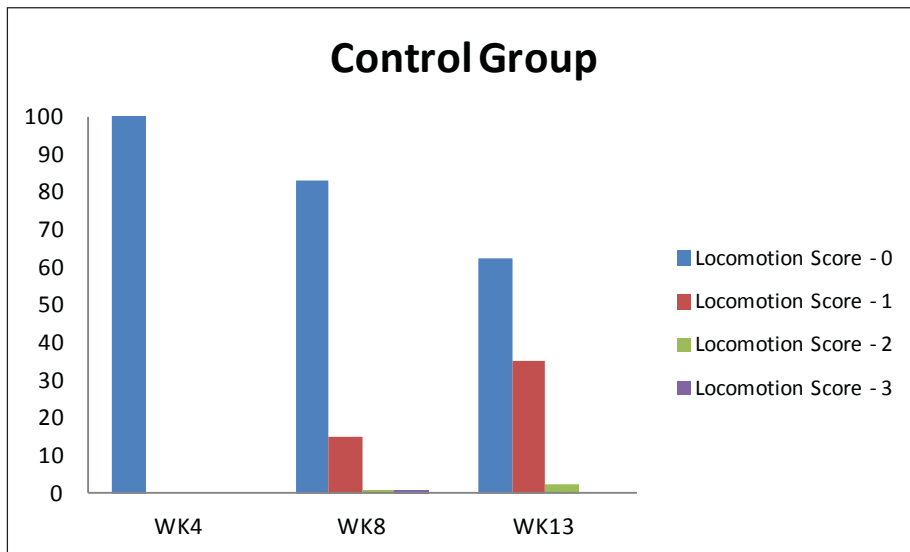

Figure 3. The number of control group sows observed in each locomotion score at three observations over gestation.

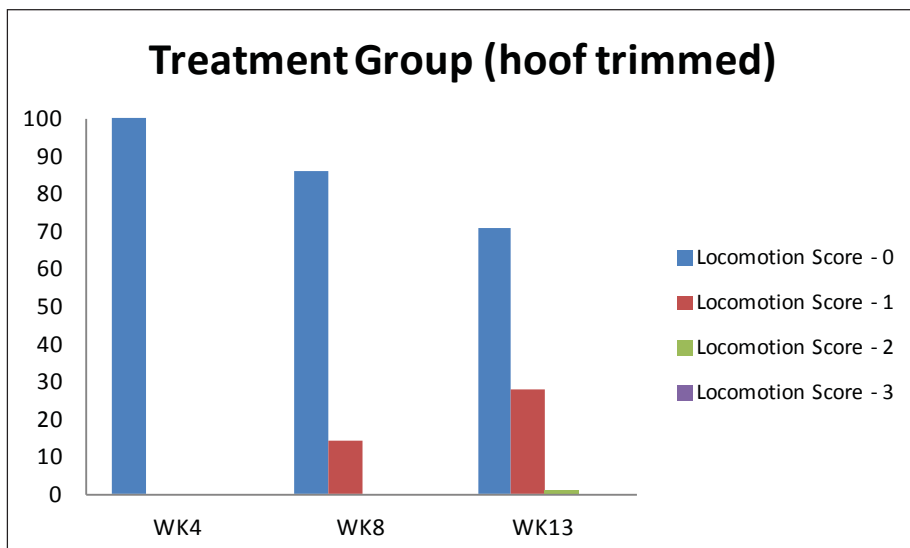

Figure 4. The number of treatment group sows observed in each locomotion score at three observations over gestation, having received a hoof trim at week 8 of gestation.

Effect of Rubber Flooring and Social Grouping on the Utilisation of Free Space for Sows in Walk-in/lock-in Stalls

F.C. Rioja-Lang, J.A. Brown, Y.M. Seddon and H.W. Gonyou



Fiona Rioja-Lang



Jennifer Brown

SUMMARY

Walk-in/lock-in stalls (also known as free access stalls) are a group housing system that provides sows with individual feeding protection, with the ability for sows to also freely enter or leave the stalls to loaf in a communal “free space” area. Walk-in/lock-in stalls are a very flexible system that is relatively easy to manage compared to other group housing systems, but a common finding is that many sows tend to remain in the stalls, and thus do not gain the benefits associated with group housing. This study investigated whether the addition of rubber mats to the free space area of two pen configurations would increase the amount of time that sows spend in this area. A second objective of the study was to examine the effects of grouping high and low parity sows separately, to determine if this would result in the increased use of the free space area by younger, lower parity sows. Results show that in the I-pen configuration, both ‘young’ and ‘old’ sow groups spent significantly more time in the areas with rubber flooring than concrete flooring ($P < 0.05$), while in the T-pens, only the young group increased their use of the free space area when rubber applied. Sow body posture on the rubber flooring indicated an increase in sow comfort, with a greater amount of lateral lying observed.

INTRODUCTION

One alternative to gestation stalls are walk-in/lock-in stalls, a group housing design which provides sows with individual feeding protection, and gives them free choice to remain in either a communal area or protected in a stall. A previous study at the Prairie Swine Centre investigated the use of communal loafing areas by sows in of walk-in/lock-in stalls and found that, although the majority of sows did use the free space areas (> 95%), most did not use the space on a regular basis or for extended periods of time. More than half the animals in that study spent <5% of their time in the free space area, and the average usage was approximately 18%.

It was also apparent that older, heavier sows utilised the free space area the most, leading to the conclusion that younger sows choose to remain in stalls due to social stress- specifically fear of older sows. The objectives of this study were to investigate if it is possible to increase the amount of time that sows spend in free access areas by: i) fitting rubber mats in the free space area to increase sow comfort, and ii) grouping sows of similar parity to reduce fear in younger/smaller (subordinate) animals.

“In I-Pen’s young and old sow groups spent significantly more time in the areas with rubber flooring than concrete”

EXPERIMENTAL PROCEDURE

The study was conducted at the Prairie Swine Centre’s dry sow unit, with walk-in/lock-in gestation pens. Sixteen groups of 16 sows were studied using three experimental treatments, arranged in a 2x2x2 factorial design. The treatments consisted of 1) being



Figure 1. Rubber slats installed in an I-pen.

housed in the 'I' or 'T' pen configuration; 2) with either rubber mats (T-pens) or rubber slats (I-pen, see Fig. 1) or concrete flooring; and 3) in groups of high parity sows (parity 3.3 ± 1.9 ; mean \pm S.D) or low parity sows and gilts (parity 0.4 ± 0.6 ; mean \pm S.D). Figure 2 demonstrates how the rubber slats were installed in the I-pens. The 'I' pen consists of an alley (3.0m x 10.7m) with slatted flooring running between two lanes of 16 stalls on each side. Any additional stalls, surplus to the group number were locked for the purposes of the trial. The second pen configuration is referred to as the 'T' pen and consists of an identical alley with the addition of a solid floor loafing area at one end (3.8m x 7.1m).

Pigs were moved from the breeding room into the gestation room at five weeks post-breeding, and were individually weighed and marked with livestock paint. The first week after grouping was used to ensure that the gilts and sows were familiar with how to open and close the stalls. A technician worked with sows each day, training them to exit and enter the stalls. Photographs were taken from mounted cameras set to shoot automatically at five minute intervals over a 24 hour period, once per week, throughout eight consecutive weeks during the gestation period. Photographs were

analysed for sow behaviour (number of sows utilising free space and lying postures) by a trained observer. Once per week both the sows and the pen floors were assigned a cleanliness score, ranging from 0 (completely clean) to 4 (body, flank, legs, and hooves/entire pen soiled).

RESULTS

Space usage

There was no significant difference between the average usage of free space area between young (low parity) and old (high parity) groups. This result is different from that of a previous study conducted at the Prairie Swine Centre where all sow groups were of mixed parity, and in which the older, heavier sows utilised the free space more frequently than younger sows. In this study, young and old sows were housed separately, and thus the younger sows were likely more confident to exit the stalls due to the absence of older, more dominant sows. The overall usage of free space in the present study was similar to that found previously, with most sows spending less than 10% of time outside the stalls. There was a significantly greater use of free space areas with rubber flooring compared to concrete flooring ($P < 0.001$), with the exception of older sows housed in T-pens (no significant difference between rubber and concrete flooring). The greatest difference in usage

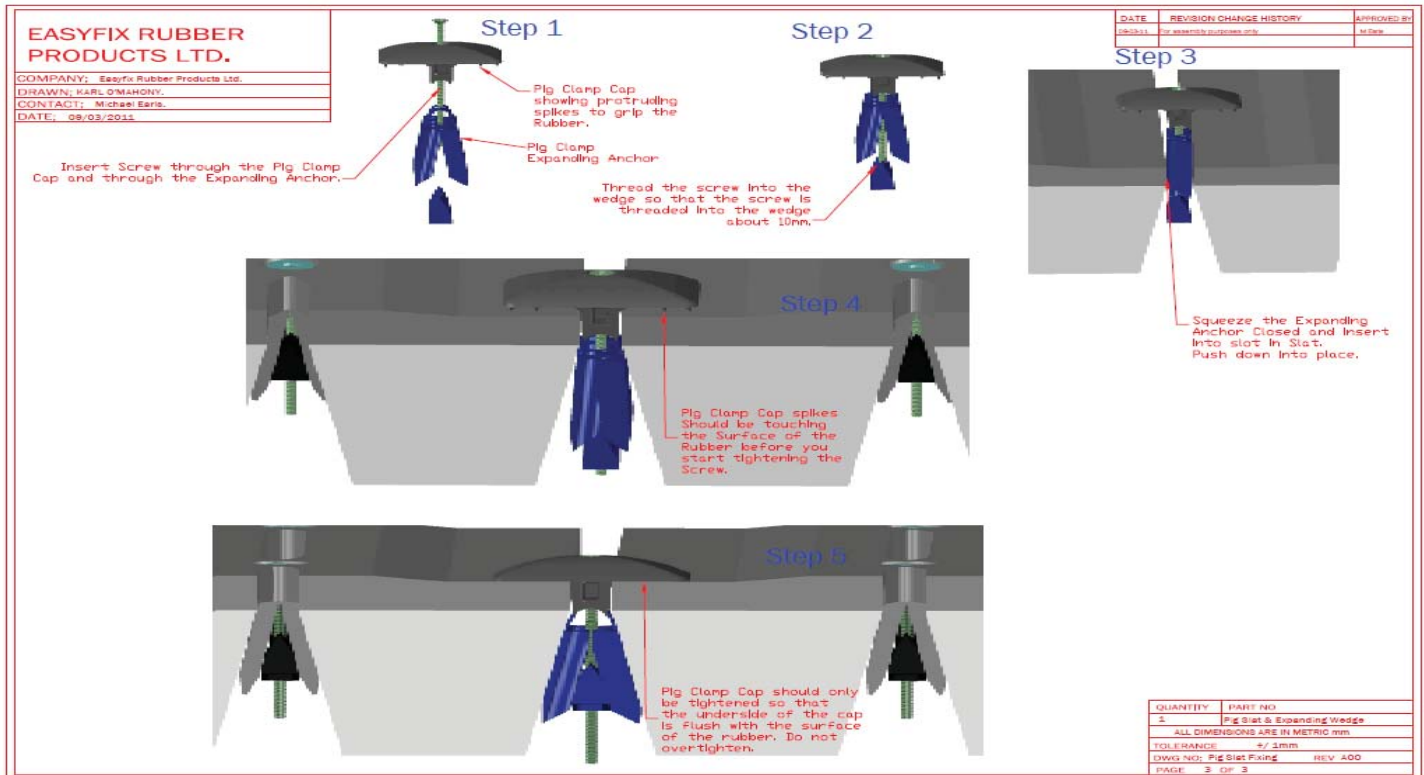

Figure 2. EasyFix Rubber Products™ patented sow slat attachment system.

between rubber and concrete flooring was observed in the I-pen configuration, with sows spending an average of 14% of their time out of stalls (min = 0%, max = 71%). These results suggest that the combination of rubber flooring and social grouping have helped encourage young sows and gilts to access the free space. However, in order to get optimal benefits from this housing system, there is still a need to increase the overall usage of free space areas, perhaps by the addition of enrichment or water drinkers in the free space. The training of young sows and gilts to access and exit the stalls in the initial week also appears to be beneficial, and this practice is recommended for those operating similar walk-in lock-in housing systems.



Figure 3. A sow shown lying laterally on solid rubber matting in a T-pen.

Sow Posture

While sows were lying in the free space areas, high levels of lateral lying (Fig. 3) were observed in both pen configurations (I and T), with significantly more lateral lying observed on the rubber flooring. Sternal lying (upright on the chest) was higher in the pens with concrete flooring. Lateral lying is a sign of comfort in sows, so these results indicate that the sows were more comfortable on the rubber mats. Lying comfort is an important component of swine welfare, as sows in intensive housing systems are known to spend up to 80% of their time lying.

Cleanliness

Sow cleanliness scores show that sows in pens with rubber floors were significantly dirtier than sows from pens with concrete floors. Although this result was statistically significant, the differences were minimal, and the overall scores of all the sows in all the treatments were relatively low. Most sows received cleanliness scores of 1 and 2, with few sows scoring 3, and no sows scored as 4. The cleanliness of flooring in each pen was also scored weekly, and no significant differences were found between rubber and concrete, or I- and T- pen configurations. This result indicates that pen cleanliness was not compromised by using rubber. Another consideration that has yet to be fully determined is the long term maintenance and durability of the rubber flooring. During the study

regular maintenance of the flooring was required, especially in I-pens, where some sows were able to root up sections of the rubber flooring. Thus improvements in rubber slat attachment are needed to make this a practical solution in commercial practice.

CONCLUSIONS

The addition of rubber flooring to walk-in/lock-in stall housing was effective at increasing the use of free space areas by gestating sows, and was particularly effective for low parity sows and gilts. Although the addition of rubber mats resulted in a significant increase in use of the free space area, overall usage averages < 10% of the time for most individuals. The quality of the free space area offers no resources (food or water) and nothing for sows to do upon exiting their stalls (ie environmental enrichment). To further increase usage of the free space, it may be helpful to add enrichment such as straw racks, drinkers, or enrichment devices. The goal of adding such resources would be to maximise the exercise benefits of group housing, and to encourage use of the free space area while reducing dominance and aggressive interactions between sows.

ACKNOWLEDGEMENTS

The authors gratefully acknowledge specific project funding for this study provided by the Alberta Livestock Meat Agency. Rubber flooring used in this research was donated by EasyFix Rubber Products of Ireland. Strategic program funding to the Prairie Swine Centre was provided by Sask Pork, Alberta Pork, Manitoba Pork Council, and the Saskatchewan Agricultural Development Fund.

Identifying the Cause of Death of Hogs that Perish In-Transit: A Pilot Project at Two Ontario Packing Plants

K. Zurbrigg and T. van Dreumel



Kathy Zurbrigg



Tony van Dreumel

SUMMARY

Market hog shipping mortalities are commonly assumed to be due to heat exhaustion or stress although the actual cause of death is seldom identified. Determining the cause of death and the associated risk factors is important if we are to reduce in-transit losses. To accomplish this, hogs that died in transit to two federally inspected slaughter plants in Ontario were necropsied to determine the cause of death.

RESULTS AND DISCUSSION

A total of 75 hogs (65 in-transit deaths (ITD) and 10 recumbent hogs that were euthanized prior to unloading at the plant) had a post mortem completed to determine their cause of death between May 2012 and February 2013. Cardiac abnormalities associated with heart failure were the most consistent pathology found in 61 of the 75 hogs that died in-transit (81%). It was apparent that the heart defects were present for weeks to months prior to the death of the pig. Less than 20% (14/75) of the market hogs that died in transit had lesion-free hearts. Frequently the only finding in hogs without heart lesions was pulmonary congestion and edema which can be an indicator of death by heat stress or asphyxiation as well as cardiac failure. Cardiac abnormalities were not always visible on gross examination but were identified on microscopic examination.

The ITD hog hearts were compared to non-ITD hog hearts. A random sample of 51 non-ITD hearts was collected from the processing line at the slaughter plants to serve as a control group for heart abnormalities. All of these hearts appeared normal on visual inspection but 45% (23/51) of the non-ITD hearts had microscopic heart lesions of the same type but not the same severity as found in the hearts of hogs that died in transit.

The visible lesions found in the ITD hearts and the microscopic lesions found in both the ITD and non-ITD hearts are similar to the lesions found in people with a disease called hypertrophic cardiomyopathy (HCM). HCM is a genetic heart disease recognized in humans, and some breeds of cats and dogs which can cause sudden death.



ONTARIO PORK

Compared to all other species (including humans), a pig's heart is small in relation to its body size (1). As a result, pig hearts are working at close to their maximum output during normal daily activities. Therefore there is little reserve when the need arises to pump more blood such as when physical demands increase. When the heart is abnormal, there is even less reserve capacity to respond to challenges. When an abnormal heart is challenged with any type of stress (eg. fighting, being restrained or being loaded or unloaded onto a truck), the heart is often unable to compensate further and heart failure occurs. Even though heart lesions were present in non-ITD hogs, they were only found at the microscopic level and were not considered severe enough to cause heart failure.

Statistical analyses demonstrated a significant relationship between the hogs that died in transit and the presence of visible heart lesions. Analyses also demonstrated that the average annual rate of in-transit loss was higher for producers where gross (visual) heart lesions were identified in the hog hearts.

All of the hearts were weighed. The total and sectioned heart weights were heavier for hogs that died in transit in comparison to the control hearts from the processing line. Hearts with abnormalities work harder to compensate for their defects (2). Because the heart is a muscle, this increased work load results in the heart muscle becoming larger and more dense. Increased heart weights are one method used to confirm that a cardiac abnormality was serious enough to result in an increased work load or stress over an extended period of time. The fact that the average heart weight of ITD hogs was significantly heavier than non-ITD heart weights supports the diagnosis of heart failure as the cause of death. The affected hearts were enlarged indicating a response to the persistent increased work loads that are associated with cardiac disease (Figure 1).

An additional sixteen hogs died and were examined during cool-cold weather, between October 2012 and February 2013. All 16 of those hogs died due to heart failure from a pre-existing heart lesion with 14/16 (88%) having HCM-like lesions. Due to the increased rate of ITD hogs during warm weather, the cause of death has traditionally been assumed to be heat stress. The majority of ITD hogs examined in this study died of heart failure due to pre-existing heart lesions, regardless of the temperature. While the cause of in-transit death loss is not often heat stress, outside temperature is associated with heart failure in ITD hogs. Increased temperatures can increase the heart rate, sometimes as much as twice the normal rate. The strength of heart contractions may also be enhanced by temperature increases (3). If a hog's heart is defective and is enlarged, the increased heart rate or strength of contraction caused by elevated temperatures during transport in warm weather, in combination with the exertion of transport, can cause the heart to fail. During the colder weather, hogs with heart lesions do not have the added risk factor of heat increasing the workload on the heart and this may explain why there are fewer ITD's in the fall and winter.

CONCLUSION

Current transportation practices are likely appropriate for the vast majority of healthy market swine. Many of the current transport losses including downer animals that must be euthanized on the truck, may be eliminated if efforts are directed in part at improving

the heart health status of pigs prior to market. This may lead to additional benefits for producers including a reduction of sudden death losses of finishing hogs on the farm. Further research is needed to identify factors associated with heart lesions in hogs. Most hogs with heart defects appear healthy and rarely express clinical signs prior to death. Hogs that become recumbent with blotchy skin and are open-mouth breathing may have cardiac defects. Producers should mark these hogs and load them with extra care preferably in a compartment by themselves. At this time, slow, low stress handling and keeping hogs cool during loading and transport continues to be the most practical recommendations for reducing transport deaths.

- 1) Friendship, R., Henry, S. 1998. Cardiovascular system, haematology and clinical chemistry. In *Diseases of Swine* 7th Ed. Chapter 1 pg 3-5
- 2) Blood, DC., Radostits, OM. 1990. *Veterinary Medicine* 7th ed. A textbook of the diseases of cattle, sheep, pigs, goats and horses. Bailliere-Tindall Publishing. Pg 301
- 3) Guyton, A., Hall, J. 2000. *Textbook of Medical Physiology*. 10th ed. WB Saunders Co. Pg 106

ACKNOWLEDGEMENTS

Funding for this research project was provided by Ontario Pork. This project could not have been completed without the cooperation and assistance of the management and staff of both abattoirs.

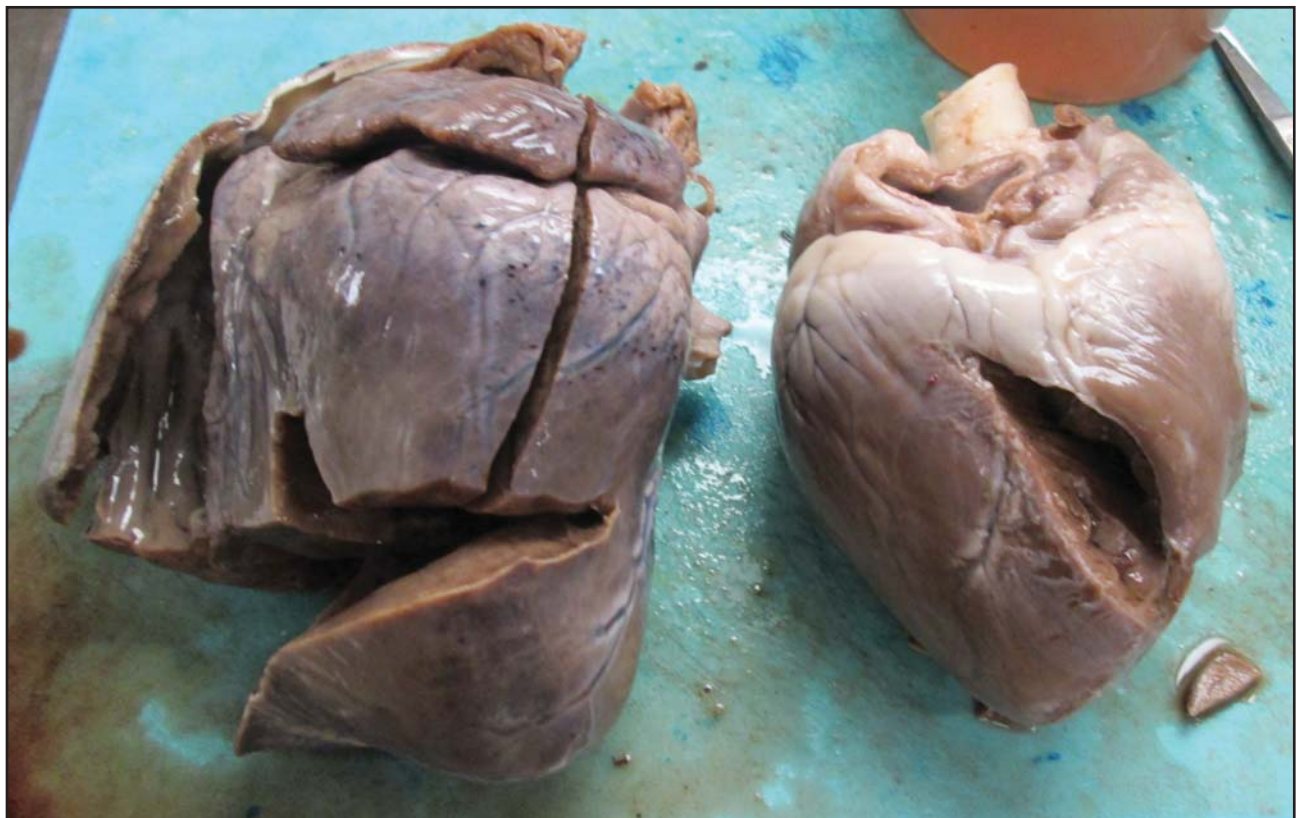

Figure 1. A heart from an ITD hog with heart lesions (left) compared to a heart without lesions taken from the processing line (non-ITD hog)

Enhancement of Litter Size in Commercial Swine

C. Tayade



Chandra Tayade

SUMMARY

Prenatal mortality is a significant concern in commercial swine. Mechanisms for this loss are not clearly defined but previous research linked poor blood supply to the developing fetuses as a leading cause. We conducted a trial utilizing biologic derived from bacteria and assessed its effects on overall litter size and postnatal health in swine.

INTRODUCTION

Prenatal mortality is a prime concern in the North American Pork Industry; 20-30% of conceptuses are lost between gestation days (gd) 15-30 and another 10-15% between gd 50-70. For > 10 years, efforts to improve litter size in commercial meat pigs by identification and selective breeding for genes responsible for uterine capacity and placental efficiency have had limited success. Studies of improved diet balance or vitamin supplements also failed. Hence, the need remains to understand critical steps controlling porcine conceptus-endometrial interactions important for fetal survival.

Previous work supported by Ontario Pork showed that endometrial lymphocytes regulate and contribute to the new blood vessel development at sites containing healthy fetuses but abruptly stop blood vessel promoting growth factor production and elevate inflammation supporting cytokines at the sites containing growth arrested fetuses. This identified endometrial lymphocytes and their products as suitable targets for therapeutic or selective breeding strategies to enhance production. Immunomodulatory molecules compatible with human food production are commercially

available. These could be safely used to mildly stimulate production of uterine cytokines and blood vessel promoting factors, which may elevate fetal survival and increased litter size. We used one such product, a biologic prepared from bacteria by a Canadian Biopharmaceutical company; Bioniche Life Sciences, Inc. We recently conducted a trial to determine if this biologic could promote litter size in commercial swine by administering at the time of insemination. The preliminary results are very promising and are discussed below.



ONTARIO PORK

RESULTS AND DISCUSSION

A biologic from Bioniche Life Sciences, Inc was administered in sows at the time of insemination and its effects were evaluated on litter size and overall postnatal growth. Results from that trial indicated that litter size was increased ~2 piglets in treated group compared with control. This increase in litter size at birth did not negatively affect piglet weight or overall health. We were able to successfully wean larger litters from treated sows compared with control, without affecting the piglet weight and health parameters. Further, we demonstrated that piglets born to treated sows took similar days to attain market weight compared with piglets born to control sows. There was no difference in the meat parameter between pigs born to treated sows versus control.

CONCLUSION

These results clearly demonstrate that the biologic used in the present study has significant potential to stimulate litter size in commercial swine. Due to intellectual property matters no details on the biologic or specifics of the treatment can be published at this time.

ACKNOWLEDGEMENTS

This research work was supported by Ontario Pork, Bioniche Life Sciences, Inc, Natural Sciences and Engineering Research Council and Ontario Ministry of Agriculture and Food. We would like to thank staff at the Arkell Swine Research Station, University of Guelph for animal care and management.

Departments of Biomedical and Molecular Sciences, Queen's University, Kingston, ON and Biomedical Science, University of Guelph, Guelph, ON

Creep Feeding in the Farrowing Room: Do the Outcomes Depend on Weaning Age?

J.N. Shea, A.D. Beaulieu, D. A. Gillis and J. Brown



Janice Shea



Denise Beaulieu

SUMMARY

Creep feed could benefit older weaned piglets by supplementing nutrients in sows' milk. Additionally, it could aid the transition to solid feed at weaning, perhaps more of a benefit to the younger weaned piglet. In our experiment, body weight at nursery exit was greater in piglets offered creep feed for one week prior to weaning, regardless of weaning age (3 vs 4 wk weaning). However, less than 4 % of the piglets weaned at 3 weeks of age showed evidence of creep feed consumption.

INTRODUCTION

Offering supplemental feed in the farrowing room (creep feeding) is thought to benefit piglets by 1) providing supplemental nutrition, 2) introducing piglets to solid feed prior to weaning and 3) adapting the gastrointestinal tract to nutrients not found in the sow's milk.



Figure 1. Configuration of the creep feeder used in the experiment

In 2010, however, we reported that providing creep feed for 7 days prior to weaning did not improve litter performance post-weaning and this was irrespective of piglet weaning weight (Beaulieu et al., 2010 Annual Report; Weaning at 28 days: Is creep feeding beneficial?). We followed this up with a study in which we tracked consumption of creep feed and phase one diet by individual piglets. This study demonstrated that, while only a small proportion of piglets consumed creep feed during the 7 days pre-weaning, those who did had improved growth performance throughout the nursery period (Beaulieu et al., 2011 Annual Report; Creep feed provision in the farrowing room provides benefits to piglets showing evidence of intake). The present study aims to expand on these findings by investigating whether the benefits of creep feeding depend on weaning age.

MATERIALS AND METHODS

This experiment consisted of 4 treatments in a 2×2 factorial arrangement. The factors were: provision, or not, of creep feed in the farrowing room and weaning at 3 or 4 weeks of age. For piglets assigned to receive it, creep feed was made continuously available in a multi-space creep feeder (Figure 1) for 7 days prior to weaning. Both the creep feed and the phase one nursery diet were marked with an inert food dye (Brilliant Blue and ferric oxide (red), respectively). Anal swabs taken from the piglets receiving creep feed 1 day prior to weaning and from all piglets 2 days post-weaning allowed us to relate post-weaning growth performance to consumption of creep feed and to explore whether consumption of creep feed pre-weaning encourages consumption of phase one diet immediately post-weaning.

RESULTS AND DISCUSSION

As expected, piglets weaned at 3 weeks weighed less at weaning than those weaned at 4 weeks ($P < 0.0001$; Table 1). This pattern persisted through the first 14 days post-weaning ($P < 0.0001$); however, by nursery exit (8 weeks of age, regardless of age at weaning) piglets weaned at 3 weeks were heavier than those weaned at 4 weeks ($P < 0.05$; Table 1).

The provision of creep feed in the farrowing room did not affect piglet body-weight at weaning and there were no creep feed by weaning age interactions ($P > 0.50$; Table 1). Growth ($P < 0.05$) and ADFI ($P < 0.0001$) of piglets who had been offered creep feed in the farrowing crate were greater than those who had not and piglets who had been offered creep feed in the farrowing room were heavier at nursery exit than piglets not offered creep feed ($P \leq 0.01$; Table 1).

Table 1: The effects of weaning age (3 versus 4 weeks) and the provision of creep feed in farrowing on the post-weaning growth performance of piglets^a

Performance Parameter	Weaning Age		Creep Status		SEM	P-Values		
	3 weeks	4 weeks	Creep ^b	No Creep		Age	Creep	Age x Creep
n, litters	40	40	40	40				
n, piglets	435	442	430	447				
Body-Weight, kg								
Day -7 ^c	3.79	5.24	4.56	4.47	0.12	<0.0001	0.55	0.66
At Weaning (Day 0)	5.51	6.96	6.33	6.13	0.13	<0.0001	0.26	0.78
Day 7 post-wean	6.15	7.87	7.18	6.84	0.14	<0.0001	0.07	0.68
Day 14 post-wean	7.81	9.92	9.15	8.59	0.18	<0.0001	0.03	0.50
Nursery Exit ^d	20.04	18.50	19.90	18.64	0.38	0.01	0.01	0.91
Average Daily Gain, kg								
7 d Pre-Wean	0.24	0.25	0.26	0.23	0.25	0.85	0.02	0.63
Day 0 to 7	0.09	0.13	0.12	0.10	0.01	0.001	0.03	0.06
Day 7 to 14	0.22	0.30	0.28	0.25	0.01	0.0002	0.01	0.29
Day 0 to Nursery Exit	0.40	0.40	0.42	0.38	0.01	0.61	0.01	0.65
Average Daily Feed Intake, kg								
Day 0 to 7	0.10	0.13	0.13	0.10	0.003	<0.0001	<0.0001	0.01
Day 7 to 14	0.26	0.33	0.31	0.28	0.005	<0.0001	<0.0001	0.0004
Day 0 to Nursery Exit	0.52	0.49	0.52	0.49	0.01	0.001	<0.0001	0.24
Gain:Feed, kg/kg								
Day 0 to 7	0.96	1.02	0.96	1.02	0.06	0.57	0.42	0.56
Day 7 to 14	0.89	0.88	0.90	0.88	0.03	0.79	0.66	0.49
Day 0 to Nursery Exit	0.78	0.81	0.80	0.79	0.01	0.17	0.63	0.81

^a Data is presented as litter averages

^b Includes data from all litters to which creep feed was offered, regardless of whether or not individual piglets showed evidence of creep feed consumption

^c Creep feed was made available to those litters assigned to receive it for 7 days prior to weaning

^d All piglets exited the nursery at 8 weeks of age, irrespective of whether they were weaned at 3 – or 4 weeks of age

In the 3 week weaning age group, only 8 piglets (4%) showed evidence of having consumed creep feed; whereas 73 four-week weaned piglets (34%) showed evidence of having consumed creep feed (Table 2). Creep feed disappeared at a rate of 57 g per litter per day for litters weaned at 3 weeks of age and 203 g per litter per day for litters weaned at 4 weeks of age ($P < 0.0001$).

Within the 3 week weaned piglets, creep-feed “eaters” were the lighter birth-weight piglets. Although these piglets had a greater rate of body-weight gain during the second week in the nursery, they were still lighter than the “non-eaters” at nursery exit (Table 2).

Piglets weaned at 4 weeks of age, identified as “eaters” of creep feed had greater rates of body-weight gain throughout the nursery phase than those identified as “non-eaters” of creep feed. Piglets who consumed creep feed in the farrowing crate were heavier, both at weaning and at nursery exit than those who did not (Table 2).

Within the 3 week weaning age group, 84 piglets (19%) showed evidence of having consumed phase one diet within the first 24 h post-weaning; whereas 142 (32%) of 4 week weaned piglets showed evidence of having consumed phase one diet within the first 24 h post-weaning.

Irrespective of creep feed status in the farrowing room, consumption of phase one diet within 24 h of weaning was associated with improved rates of BW gain during the first week in the nursery in both 3 and 4 week weaned piglets. In 4 week weaned piglets, this improvement in ADG persisted throughout the nursery period (0.42 vs. 0.38 kg/d for “eaters” and “non-eaters” of phase one, respectively), such that 4 week weaned piglets who consumed phase one diet within 24 h post-weaning were heavier at nursery exit than those who did not (19.01 vs. 18.07 kg, respectively). Irrespective of creep feed status in the farrowing room, consumption of phase one diet within 24 h of weaning was associated with

Table 2: Effects of creep feed consumption^a on the growth performance of piglets weaned at 3 – or 4 weeks of age

Growth Performance Parameter	Weaned at 3 Weeks		Treatment Weaned at 4 Weeks		Main Effects of Creep	
	Creep Feed “Eater”	Creep Feed “Non-Eater”	Creep Feed “Eater”	Creep Feed “Non-Eater”	Creep Feed “Eater”	Creep Feed “Non-Eater”
n, piglets	8	206	73	143	81	349
Body-Weight, kg						
Birth	1.51	1.79	1.62	1.68	1.61	1.75
Day -7 ^b	3.43	3.89	5.22	5.00	5.04	4.35
Day 0 (weaning)	5.11	5.66	7.02	6.74	6.83	6.10
Day 7	5.74	6.30	8.37	7.65	8.11	6.86
Day 14	7.64	7.94	10.88	9.70	10.56	8.66
Nursery Exit ^c	20.14	20.53	19.97	18.07	19.99	19.53
Average Daily Gain, kg						
Day -7 to 0	0.24	0.25	0.26	0.25	0.26	0.25
Day 0 to 7	0.09	0.09	0.19	0.13	0.18	0.11
Day 7 to 14	0.27	0.23	0.36	0.29	0.35	0.25
Day 0 to Exit	0.42	0.41	0.45	0.39	0.44	0.40
Average Daily Feed Intake kg						
Day 0 to 7	0.11	0.10	0.15	0.14	0.15	0.12
Day 7 to 14	0.26	0.26	0.38	0.36	0.36	0.30
Day 0 to Exit	0.53	0.52	0.52	0.51	0.52	0.52
Feed Conversion Efficiency, kg/kg						
Day 0 to 7	0.90	0.92	1.25	0.89	1.22	0.91
Day 7 to 14	1.05	0.89	0.94	0.80	0.95	0.85
Day 0 to Exit	0.79	0.79	0.85	0.76	0.85	0.78

^a Data-set includes only those piglets to whom creep feed was offered. Data unbalanced and not analyzed statistically

^b Creep feed was provided from day -7 to day 0 i.e. for the week prior to weaning

^c All piglets exited the nursery at 8 weeks of age, irrespective of their age at weaning

improved rates of BW gain during the first week in the nursery in both 3 and 4 week weaned piglets. In 4 week weaned piglets, this improvement in ADG persisted throughout the nursery period (0.42 vs. 0.38 kg/d for “eaters” and “non-eaters” of phase one, respectively), such that 4 week weaned piglets who consumed phase one diet within 24 h post-weaning were heavier at nursery exit than those who did not (19.01 vs. 18.07 kg, respectively).

Regardless of age at weaning, piglets who consumed both creep feed in the farrowing crate and phase one diet within 24 h post-weaning were heavier and had greater rates of body-weight gain throughout the nursery period than any other group of piglets (Data not shown).

CONCLUSIONS

Creep feeding in the farrowing room improved the weaning and nursery exit weights of the piglets who actually consumed it. Although the benefits of creep feeding were similar in piglets weaned at 3 or 4 weeks of age, there was a dramatic difference in the number of piglets that consumed the offered creep feed. Further research into ways of encouraging creep feed consumption among piglets is required.

ACKNOWLEDGEMENTS

The authors thank Masterfeeds for donating the creep feed used in this experiment. Strategic funding provided to the Prairie Swine Centre by Sask Pork, Alberta Pork, the Manitoba Pork Council, Ontario Pork and the Saskatchewan Agriculture and Food Development Fund is gratefully acknowledged.

Spray-Dried Animal Plasma Mitigates the Negative Impact of Deoxynivalenol (DON) in Nursery Pigs

L. Eastwood, J. N. Shea, D. A. Gillis, L. Johnston, and A.D. Beaulieu



Janice Shea



Laura Eastwood

SUMMARY

Deoxynivalenol (DON) is a mycotoxin of concern to grain and livestock producers in Canada. It is prevalent in cool, temperate regions and often occurs on wheat and barley. The use of DON contaminated grain in livestock feed leads to depressed feed intake and growth performance. Pigs are especially susceptible to its negative effects relative to other livestock species, and thus a study was carried out to determine if the negative effects observed with feeding DON contaminated diets could be mitigated by feeding a clay binder and/or spray-dried animal plasma (SDAP). Pigs fed a DON contaminated diet plus SDAP performed as well as those consuming a non-contaminated diet in terms of ADFI and ADG.

INTRODUCTION

The presence of DON contamination in grain is directly related to the presence of head or ear blight produced by *Fusarium* fungi, which in turn is directly related to the moisture content at flowering and/or harvest. Possibly due to recent high stress growing seasons, we have seen an increase in the presence of DON contaminated grains in the Prairie Provinces, and it is expected that DON contamination will continue to spread. Grains contaminated with DON are often downgraded, and either fed to livestock or destroyed. The best strategy for dealing with contaminated grains is to reduce the final concentration of the mycotoxin by dilution; however, this may not be possible if large quantities of contaminated grain are available.

Feeding DON contaminated diets to pigs has negative effects on performance, and can also affect intestinal integrity. Contrary to this, including SDAP into swine rations leads to improved performance and has positive benefits on gut health and integrity. This led to the hypothesis that feeding SDAP to pigs consuming DON contaminated diets would mitigate the negative effects on performance. The use of activated clay binders is another strategy

designed to help reduce the negative effects of certain mycotoxins in livestock, and thus we also hypothesized that adding an activated clay to the diet would improve animal performance in DON fed pigs.

MATERIALS AND METHODS

Two blocks of 100 nursery pigs each were used for this trial. Pigs were housed in groups of 5/pen with a total of 8 pens per dietary treatment. Pigs began consumption of experimental diets 3 days post weaning and remained on trial for 20 days. Body weights and feed intakes of the pigs were measured on days 0, 3, 11 and 20. Intestinal samples were collected from the jejunum and ileum for 8 pigs per diet at the end of the trial for histological analysis.

Diets consisted of a negative control (NC; 0 ppm DON), a positive control (PC; 3.9 ppm DON) and 3 treatment diets which consisted of the PC diet plus clay (PC+clay), SDAP (PC+plasma) or both (PC+both). Diet formulations are shown in Table 1.

“Pigs fed a DON contaminated diet plus SDAP performed as well as those consuming a non-contaminated diet in terms of ADFI and ADG.”

RESULTS AND DISCUSSION

Throughout the course of the experiment we observed no evidence of animals being ill (no vomiting or diarrhea). Overall, relative to the negative control (NC; no DON), ADG and ADFI of pigs fed the positive control (with DON) were reduced by 60 and 100 g/d respectively ($P < 0.01$). There was no obvious benefit of supplementing the diets with the clay binder, as ADG of pigs consuming the PC+clay diet was similar to those consuming the PC diet ($P > 0.05$); feed intake, however, of pigs fed the PC+clay was numerically improved relative to the PC but was less than the NC (PC+clay 450 g/d, PC 400 g/d, NC 500 g/d).

When SDAP was added to the DON contaminated diet (PC+plasma), ADG of pigs was similar to the NC pigs (420 g/d vs. 390 g/d; $P > 0.05$). The ADFI however, was greater for pigs consuming PC+plasma than the NC pigs (550 g/d vs. 500 g/d; $P < 0.01$). Performance of pigs fed the PC+both diet was also similar to the NC and PC+plasma fed pigs. Overall, gain:feed averaged 0.79 and was unaffected by DON, SDAP or the activated clay ($P > 0.05$). The effects of dietary treatment on ADG and ADFI are shown in Figures 1 and 2.

In the intestine, mucosal thickness and villus height were unaffected by dietary treatment. Pigs fed a DON contaminated diet plus SDAP (PC+plasma) had reduced crypt depth ($P = 0.04$) and thus the villus height to crypt depth ratio tended to be higher.

CONCLUSION

Inclusion of SDAP improved ADFI and ADG relative to the positive DON control, and pigs consuming SDAP with DON performed as well as the negative controls. SDAP alleviated the negative effects of DON. In this experiment, SDAP was more effective than the activated clay. SDAP should be included into nursery diets if DON contaminated feed is suspected or known.

ACKNOWLEDGEMENTS

Strategic program funding was provided by Sask Pork, Alberta Pork, Manitoba Pork Council, Ontario Pork and Saskatchewan Agriculture and Food Development Fund. Specific funding for this project was provided by Saskatchewan Agriculture and Food Development Fund.

Table 1. Diet Formulations

Ingredients ^{1,2} , % as fed	Treatment				
	NC	PC	PC + Clay	PC + Plasma	PC + Both
Wheat	50.8	28.8	28.6	27.8	27.6
DON Wheat (9.3 ppm)	0.0	22.0	22.0	22.0	22.0
Soybean Meal	19.0	19.0	19.0	18.1	18.1
Whey Powder	11.7	11.7	11.7	11.4	11.4
Fish Meal	9.0	9.0	9.0	0.0	0.0
Barley	4.9	4.9	4.9	5.8	5.8
Canola Oil	2.3	2.3	2.3	2.4	2.4
LS 20	0.1	0.1	0.1	0.1	0.1
Activated Clay	0.0	0.0	0.2	0.0	0.2
SDAP	0.0	0.0	0.0	8.0	8.0
Analyzed DON, ppm	0.0	3.2	3.6	4.2	4.4

¹All diets contained equal amounts of vitamin and mineral premixes, choline chloride, salt and CuSO₄·5H₂O

²Amino acids, limestone, and mono/di-calcium phosphate were added to balance diets

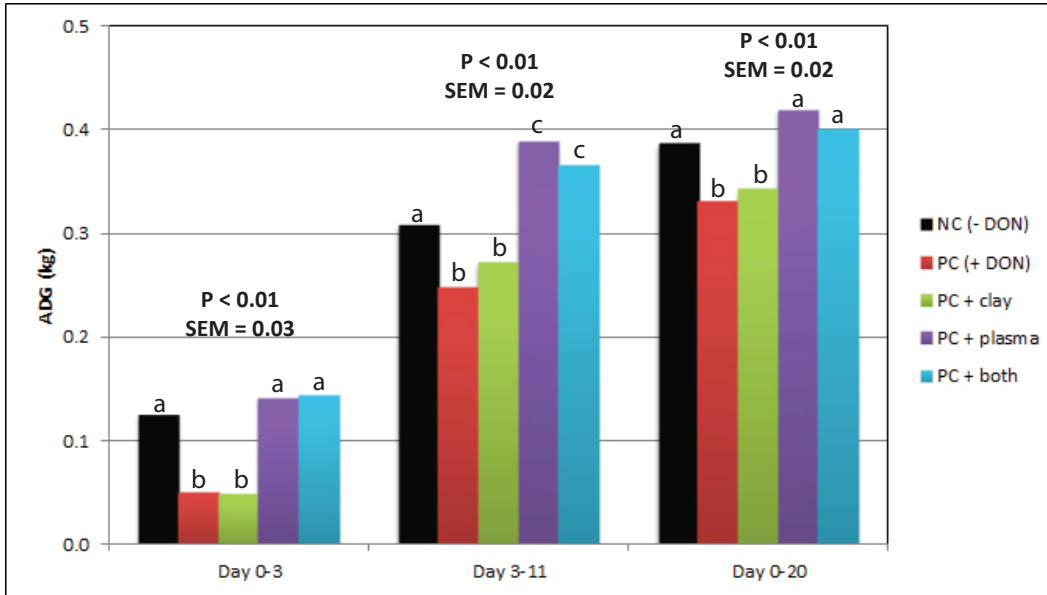

Figure 1. Average daily gains of piglets fed diets containing DON contaminated wheat +/- additives relative to a negative control.

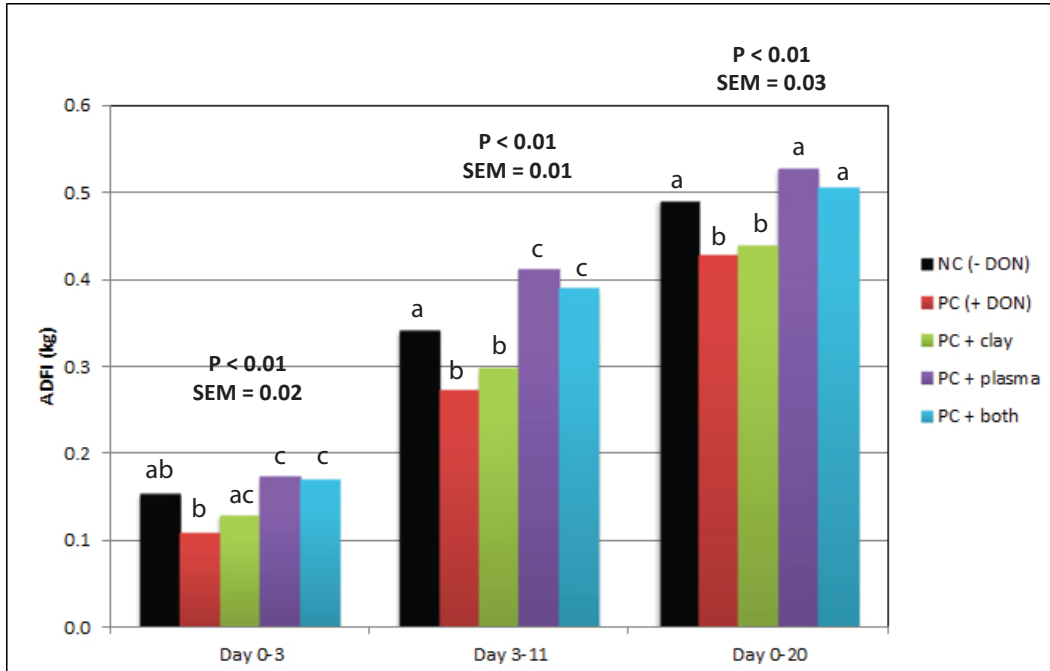

Figure 2. Average daily feed intakes of piglets fed diets containing DON contaminated wheat +/- additives relative to a negative control

Effects of Altering the Omega-6 to Omega-3 Fatty Acid Ratio in Starter Diets on Piglet Inflammatory Response

L. Eastwood, and A.D. Beaulieu



Laura Eastwood



Denise Beaulieu

SUMMARY

An experiment was conducted to determine the effects of altering the omega-6 (n-6) to omega-3 (n-3) fatty acid (FA) ratio in starter diets on the inflammatory responses of piglets post-weaning. Piglets were subjected to an inflammatory challenge by injecting lipopolysaccharide (LPS), a component of gram-negative bacteria which triggers an immune response. Weanling pigs fed diets containing different n-6:n-3 FA ratios responded differently to an LPS induced immune challenge, and thus the FA profile of a ration may affect the response of piglets to inflammatory challenges in the nursery.

INTRODUCTION

Weaning is a critical time in a piglet's life. They are exposed to many new stressors, including immune challenges. These stressors can lead to reduced feed intake and growth, and an inflammatory response will be generated. Although a certain degree of inflammatory response is beneficial during this time, an over-production of immune cells can be detrimental, leading to increased muscle degradation and reduced protein synthesis.

“Weanling pigs fed diets containing different n-6:n-3 FA ratios responded differently to an LPS induced immune challenge”

The n-3 FAs are anti-inflammatory, and are known to have many different health benefits in a variety of species. Also, n-3 FAs can alter the body's release of cytokines, (proteins secreted by immune cells in response to stimuli) which assist in regulating the inflammatory response. Some of the most important pro-inflammatory cytokines are tumour necrosis factor (TNF- α), interleukin (IL)-1, IL-6 and IL-8.

This project was designed to determine if feeding a diet high in n-3 FAs post-weaning could alter the inflammatory response of piglets by reducing production of pro-inflammatory cytokines and improving piglet performance during an E.coli LPS challenge.

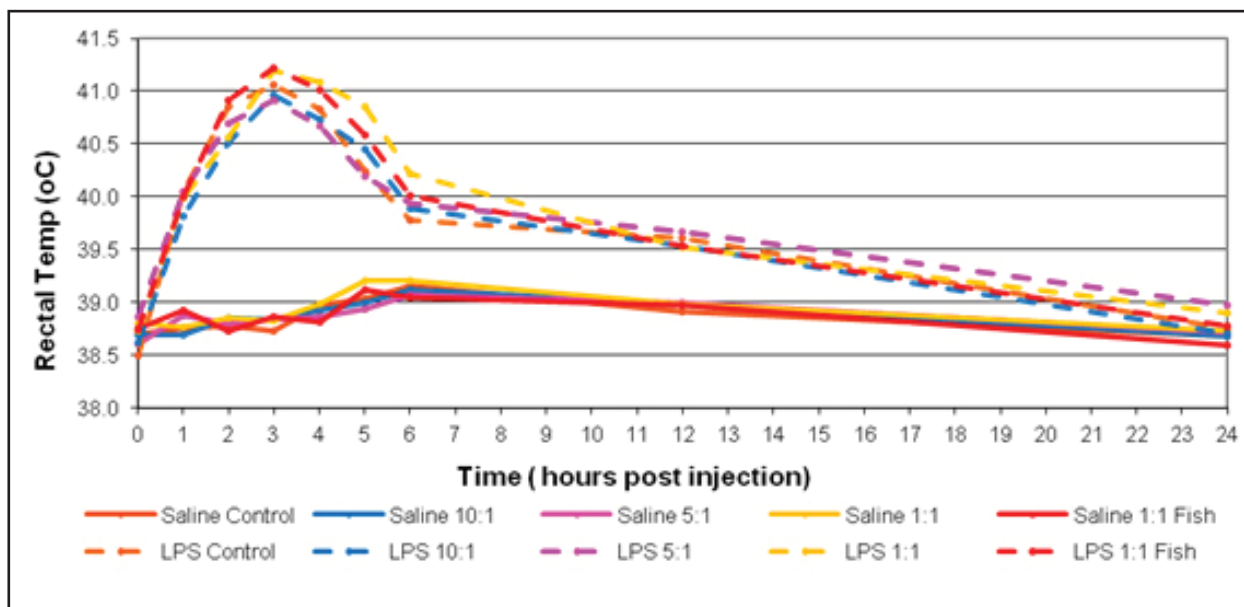

Figure 1. Average rectal temperatures of pigs treated with lipopolysaccharide (LPS) or saline after consuming varying n-6 to n-3 fatty acid ratios for one week in the nursery. No effect of diet was found for body temperature at time zero prior to challenge; $P > 0.05$. No diet x challenge interaction was observed; $P > 0.05$.

MATERIALS AND METHODS

Weanling pigs (n=120) were randomized to one of five dietary treatments immediately post-weaning (d 26 ± 2 days of age). Diets were formulated to contain varied n-6:n-3 FA ratios and consisted of a control (tallow based), plant based ratios of 10:1, 5:1, 1:1, and a fish based 5:1 ratio. Piglets were housed in groups of 2, and were given 6 days to acclimate to their surroundings and new diet prior to undergoing an inflammatory challenge. Piglets were then randomized to a challenge control group (saline injected) or to an LPS injected group (n=10/challenge/diet) and moved into individual pens for the 24 hour challenge period. Rectal temperatures were recorded at 0, 1, 2, 3, 4, 5, 6, 12 and 24 hrs post injection and blood samples were collected at 0, 2, 6 and 12 hrs post injection for cytokine analysis (IL-1 β , IL-6, IL-8, TNF- α).

RESULTS AND DISCUSSION

Piglets that were challenged with LPS consumed less feed and had reduced growth rates relative to those piglets who received a saline injection during the challenge period ($P < 0.01$).

Rectal temperatures were unaffected by dietary treatment ($P > 0.05$), but maximum body temperature was 1.8 °C higher in pigs injected with LPS relative to the saline controls, regardless of dietary treatment group ($P < 0.01$). Figure 1 shows the effects of starter diet and challenge on rectal temperatures for piglets throughout the 24 hour challenge period.

The area under the curve (representing cumulative output for the period) for plasma IL-6 was greater in pigs consuming the 5:1 plant based diets relative to those consuming the other diets ($P <$

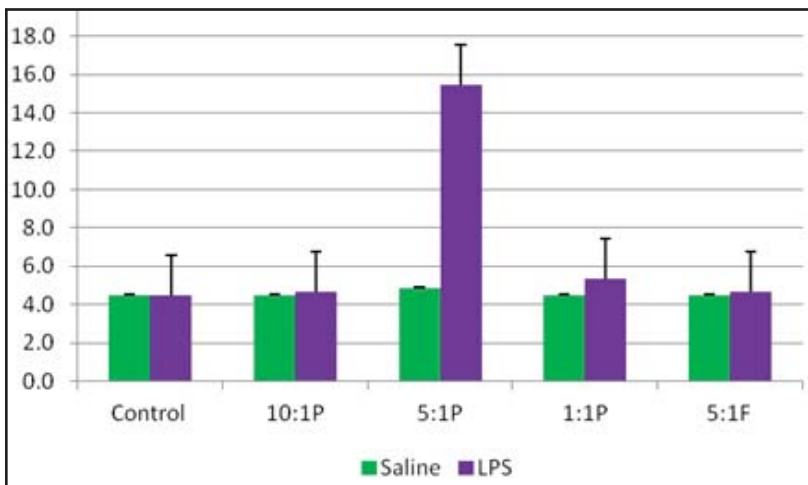

Figure 2. Diet by challenge interaction of plasma interleukin (IL)-6 concentration (mean \pm SEM) for piglets injected with saline or lipopolysaccharide (LPS) when consuming varied n-6 to n-3 ratios post-weaning.

P Values: Diet < 0.01 , Challenge 0.03, and $D \times C < 0.01$

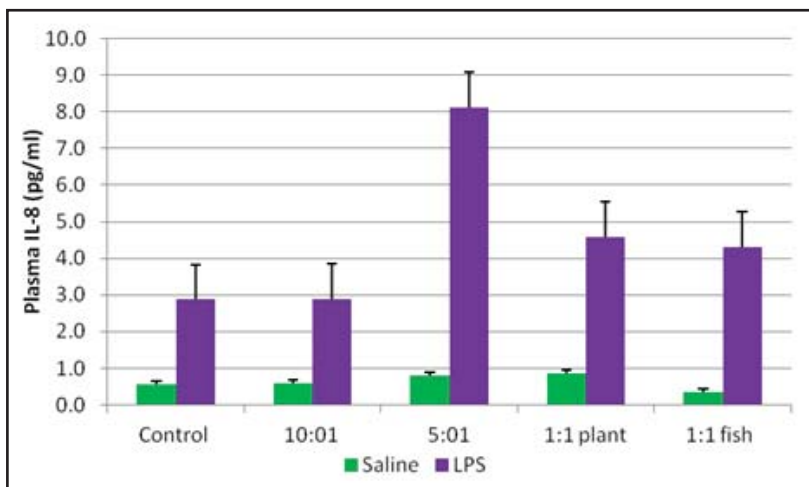

Figure 3. Diet by challenge interaction of plasma interleukin (IL)-8 concentration (mean \pm SEM) for piglets injected with saline or lipopolysaccharide (LPS) when consuming varied n-6 to n-3 ratios post-weaning.

P Values: Diet 0.08, Challenge < 0.01 , and $D \times C = 0.13$

0.01), as was the area under the curve for those injected with LPS. A diet \times challenge interaction was present for plasma IL-6, with piglets consuming the 5:1 plant based diet having an increased response when injected with LPS ($P = 0.01$; Figure 2). Similarly, there was a tendency for pigs consuming the plant based 5:1 diet to have increased plasma IL-8 during the inflammatory challenge period ($P = 0.08$). There was also a tendency for a diet \times challenge interaction, with pigs consuming the 5:1 plant based diet having a greater response when injected with LPS relative to the other diets, as shown in Figure 3.

CONCLUSIONS

Altering the n-6 to n-3 fatty acid ratio in the diets of newly weaned pigs can affect how they respond to immune challenges. Pigs consuming the intermediate n-6 to n-3 ratio of 5:1 had increased production of pro-inflammatory cytokines when challenged with LPS. Further work is required to determine the overall impact of these changes and how we can utilize them to help alleviate the post-weaning growth lag observed in the nursery.

ACKNOWLEDGEMENTS

Strategic program funding was provided by Sask Pork, Alberta Pork, Manitoba Pork Council and Saskatchewan Agriculture and Food Development Fund. Specific funding for this project was provided by Alberta Livestock and Meat Agency (ALMA) and Vandeputte s. a., Belgium.

The Efficiency of Energy Utilization by Growing Pigs Selected for Potential Growth Rate

A. D. Beaulieu, J. N. Shea, D. A. Gillis



Denise Beaulieu



Janice Shea

SUMMARY

Feeding pigs specific diets based on potential growth rate as determined by growth rate in the nursery may decrease variability in grow-out and finishing. In our study, however, pigs separated into slow, average or fast potential growth rates by determining growth rate in the nursery had comparable growth rates, feed intake and rates of protein and lipid deposition in late finishing.

INTRODUCTION

The normal variability in growth rate that exists within a group of pigs causes inefficiencies in nutrient utilization and contributes to variation in carcass composition. Managing this variability is a significant challenge for the pork industry. We have conducted a series of experiments designed to develop cost-effective feeding regimes which minimize the negative effects of variability on the producer's bottom line. The specific objective of the reported experiment is to characterize the utilization of energy by pigs of differing potential growth rate (PGR).

MATERIALS AND METHODS

This experiment used a total of 120 finishing (90 to 120 kg BW) barrows. Twenty-four pigs were assigned to an initial slaughter group (ISG) and 96 pigs were assigned to one of 12 treatments ($n = 8$ pigs/treatment). The treatments were arranged as a $3 \times 2 \times 2$ factorial and consisted of 3 potential growth rates (PGR; slow, average or fast), 2 dietary energy concentrations (EC; 2.18 or 2.40 Mcal NE/kg) and 2 levels of feed intake (FI; 85 or 100% of ad libitum intake).

Barrows were identified at nursery exit as having a slow, average or fast PGR, based on their body-weight per day of age from birth to nursery exit. When the pigs reached 90 kg BW they were randomly assigned, within PGR, to the EC and FI treatments.

Dietary energy concentration was adjusted by changing the relative proportions of wheat, barley and canola oil (Table 1). Diets were formulated to meet or exceed the pigs' nutrient requirements (NRC, 1998) and to provide a constant SID lysine-to-NE ratio and minimum essential amino acid-to-lysine ratios. Celite was included in both diets as a source of acid insoluble ash, to be used as a digestibility marker.

Table 1. Ingredient and nutrient composition of experimental diets

Item	Formulated NE Conc., Mcal/kg	
	2.18	2.40
Ingredient, % as-fed		
Barley	67.83	11.20
SBM	23.20	22.00
Wheat	4.00	59.16
Canola Oil	1.00	3.50
Mono / di Cal / P	1.40	1.45
Limestone	1.10	1.00
Salt	0.50	0.50
Vitamin premix ¹	0.06	0.06
Mineral premix ¹	0.08	0.08
DG200 Selenium	0.15	0.15
Celite	0.40	0.40
L-Lysine HCl	0.20	0.34
L-Threonine	0.04	0.10
DL-Methionine	0.05	0.07
Nutrients, as fed		
Dry Matter, %	88.93	89.81
Crude Protein, %	21.45	21.32
Crude Fat, %	2.76	5.19
Total Lysine, %	1.16	1.20
TID Lysine, %	0.95	1.02
g TID Lys/Mcal NE	4.37	4.24
DE, Mcal/kg	3.20	3.52
ME, Mcal/kg	3.01	3.29

¹Obtained from Master Feeds, Saskatoon, SK

Table 2. The effects of potential growth rate, dietary energy concentration and feeding level on the performance of barrows growing from 90 to 120 kg

Item	Potential Growth Rate (PGR)			NE Conc. (EC), Mcal/kg		Feeding Level (FL), % Ad Lib.	
	Slow	Average	Fast	2.18	2.40	85	100
n	32	32	31	47	48	48	47
BW per day of age, g	335.3	396.8	457.1	392.5	400.3	393.7	399.1
Initial BW, kg	89.6	90.2	90.8	90.0	90.4	90.2	90.2
Final BW, kg	119.1	119.7	119.2	119.3	119.4	119.3	119.5
No. Days on Test	33	32	31	32	33	35	30
ADG, kg	0.93	0.93	0.93	0.95	0.91	0.86	1.01
ADFI, kg	3.04	3.01	3.02	3.09	2.96	2.79	3.26
G:F, kg/kg	0.31	0.31	0.31	0.31	0.31	0.31	0.31

Bold font indicates $P < 0.05$

“Pigs separated into slow, average or fast potential growth rates by determining growth rate in the nursery had comparable growth rates, feed intake”

Except for the ISG group, pigs were slaughtered when they reached 120 kg BW. Carcasses were ground and analyzed for nutrient content. Dietary NE (NECST) was calculated as the sum of the energy retained in the carcass (RE) and fasting heat production (FHP), estimated according to Noblet et al. (2003) as 179 kcal/kg BW^{0.60}. Dietary NE was also estimated based on nutrient content and digestibility using prediction equations from the French National Institute for Agricultural Research (INRA; Sauvant et al., 2004).

RESULTS

Pigs were identified as having either a slow, average or fast PGR based on their BW per day of age from birth to nursery exit. Previous studies conducted at the Prairie Swine Centre have demonstrated a correlation ($r^2 \sim 0.35$) between BW at nursery exit and growth rate in the grow-finish barn. Interestingly, in the present study performance, expressed in terms of ADG, ADFI and FCE was unaffected by PGR ($P > 0.05$; Table 2).

Pigs receiving the high energy diet had reduced ADFIs ($P < 0.05$); however ADG was similar across EC treatments. By design, ADFI was greater in pigs fed at 100% of ad libitum than those fed at 85 %, which led to an increase in ADG ($P < 0.05$; Table 2).

The efficiencies with which pigs used dietary energy for BW gain and for accretion of protein and lipid in the carcass were unaffected by PGR (Table 3). Pigs fed the low energy diet were more efficient (g protein deposited/ g Mcal intake) in their accretion of carcass protein than pigs fed the high energy diet ($P < 0.05$).

Although pigs fed at 100% of ad libitum grew faster and took fewer days to reach 120kg than those fed at 85% of ad libitum, the latter were more efficient in their use of dietary energy for BW gain and for carcass protein accretion ($P < 0.05$, Table 3).

CONCLUSIONS

Growth performance and the efficiency of energy utilization for growth and for carcass nutrient accretion in finishing (90 to 120kg) pigs was similar among pigs identified at nursery exit as having a slow, average or fast potential growth rate. This suggests that segregating pigs at nursery exit based on PGR is not an effective tool to manage variability in the grow-finish herd.

ACKNOWLEDGEMENTS

The authors gratefully acknowledge the National Sciences and Engineering Research Council (NSERC) and Cargill Ltd. for funding this study; and Sask Pork, the Manitoba Pork Council, Alberta Pork, Ontario Pork and the Saskatchewan Agriculture and Food Development Fund for strategic funding provided to the Prairie Swine Centre.

Table 3. The effects of potential growth rate, dietary energy concentration and feeding level on energy utilization for nutrient retention in the carcasses of barrows slaughtered at 120 kg¹

Item	Potential Growth Rate (PGR)			NE Conc. (EC), Mcal/kg		Feeding Level (FL), % Ad Lib.	
	Slow	Average	Fast	2.18	2.40	85	100
n, pigs	32	32	30	47	47	47	47
Body-Weight Gain, kg/Mcal							
DE	0.16	0.16	0.16	0.16	0.15	0.16	0.15
NE _{CST}	0.14	0.15	0.14	0.15	0.14	0.15	0.14
NE/ _{INRA2}	0.24	0.25	0.24	0.26	0.23	0.25	0.23
NE/ _{INRA4}	0.24	0.24	0.24	0.25	0.23	0.25	0.23
Energy retention, Mcal retained/Mcal consumed							
DE	0.39	0.39	0.39	0.37	0.41	0.37	0.41
NE _{CST}	0.40	0.40	0.40	0.38	0.42	0.38	0.42
NE/ _{INRA2}	0.54	0.55	0.55	0.53	0.56	0.52	0.57
NE/ _{INRA4}	0.95	0.97	0.96	0.99	0.99	0.97	0.95
Protein deposition, g/Mcal							
DE	15.51	16.29	15.22	17.05	14.33	16.57	14.80
NE _{CST}	15.81	16.59	15.54	17.16	14.83	16.88	15.10
NE/ _{INRA2}	21.76	22.87	21.30	24.38	19.60	23.24	20.75
NE/ _{INRA4}	38.80	38.80	37.53	43.04	35.38	43.43	34.98
Lipid deposition, g/Mcal							
DE	31.28	32.32	32.45	29.43	34.59	29.27	34.75
NE _{CST}	31.97	33.05	33.13	29.62	35.79	29.90	35.51
NE/ _{INRA2}	43.68	45.11	45.38	42.10	47.32	40.89	48.53
NE/ _{INRA4}	76.12	79.19	78.92	72.89	83.23	75.85	80.26

¹ Refers to the utilization of energy available for BW gain, calculated as energy intake minus the maintenance energy requirement

Bold font indicates P < 0.05

Impact of Calcium and Phosphorus on Sow Lameness and Sow Longevity



F. Tan., and A.D. Beaulieu



Felina Tan



Denise Beaulieu

SUMMARY

The current NRC Swine (2012) recommendations for Ca and P feeding levels for gestating sows are primarily based on data for stall housed sows. Additionally, much of the literature on Ca and P requirements is older and may not be relevant to the modern, high producing sow. A trial was conducted to determine if the current recommended feeding levels of Ca and P during gestation are adequate for high producing sows housed in stalls or groups. We found that the current recommendations are adequate for group housed sows in a non-competitive group housed situation. We also observed increased performance in the group setting, with group housed sows giving birth to larger litters and heavier piglets.

INTRODUCTION

Improvements in sow productivity have raised the question of the adequacy of dietary mineral recommendations. The increase in anatomical and physiological demands of the skeletal system has led the feed industry to routinely recommend higher dietary levels of minerals including calcium (Ca) and phosphorus (P). There has been very limited research examining the Ca requirement of the modern, highly prolific sow. It is not known if the Ca requirement has changed to accommodate milk requirements of the larger litter, and/or if the sows are required to mobilize Ca from their bones for milk production. Increased Ca demands could be a potential cause of reduced longevity for our sow herd. Currently, Canadian producers are faced with extremely high feed and housing costs, and reduction in sow longevity leads to increased costs associated with raising replacement gilts.

Welfare of reproducing sows confined in stalls is a concern. Food retailers have been revisiting their purchasing strategies to not include pork from farms with individual stalls.

“Current calcium and phosphorus recommendations are adequate for group housed sows in a non-competitive group housed situation”

Confinement offers no opportunity for movement and it has been proposed that movement is required to maintain bone strength and integrity. Questions have been raised on whether the current recommended levels of Ca and P will be sufficient for animals housed in groups, with the potential for increased mobility.

To help answer these questions, an experiment was conducted to determine the influence of dietary Ca and P levels in the gestation diet of high producing sows housed in stalls or groups on Ca and P balance, productivity and bone turnover.

MATERIALS AND METHODS

The experiment was designed using a 3 x 2 factorial arrangement of treatments. A total of 180 sows were randomly assigned to each treatment group. Three dietary levels of Ca and P were used at an equal ratio; Ca 0.76%: P 0.67% (Control), Ca 0.65%: P 0.57% (-15%) and Ca 0.87%: P 0.77% (+15%). Two different housing strategies

Table 1. The effect of dietary Ca & P (15% variance from 1998 NRC recommendations) and housing on sow body weight changes during gestation and lactation and lactation feed intake

Diet	Housing	Sow's Body Weight and Feed Intake (kg)			
		BW Day 0	BW Day 100	BW Wean	ADFI Total
-15% Ca	Stall	230.6	251.8 ^a	238.9	7.00
	Group	232.8	264.2 ^b	241.4	7.06
Control Ca	Stall	229.9	260.8 ^a	246.4	7.03
	Group	238.5	270.7 ^b	253.2	6.52
+15% Ca	Stall	228.4	253.8 ^a	233.1	6.76
	Group	241.4	265.9 ^b	245.4	6.98
SEM		7.06	5.34	7.10	0.29
Statistical Analysis		P Value			
Diet		0.88	0.33	0.25	0.53
Housing		0.15	0.01	0.21	0.69
Diet*Housing		0.72	0.97	0.79	0.24

Means with the same letter in the same column are not significantly different ($P > 0.05$).

Table 2. The effect of dietary Ca & P (15% variance from 1998 NRC recommendations) and housing on piglets born, weights and average daily gain

Diet	Housing	Piglets data				
		Number Born Live	Total Litter Size	Avg. Birth Weight (kg)	Avg. Wean Weight (kg)	ADG (kg/d)
-15% Ca	Stall	14 ^a	15	1.52 ^a	6.57	0.22
	Group	15 ^b	16	1.62 ^b	6.74	0.24
Control Ca	Stall	14 ^a	16	1.46 ^a	6.56	0.23
	Group	15 ^b	15	1.54 ^b	6.60	0.23
+15% Ca	Stall	14 ^a	16	1.48 ^a	6.57	0.23
	Group	16 ^b	17	1.59 ^b	6.84	0.23
SEM		0.59	0.56	0.06	0.19	0.01
Statistical Analysis			P Value			
Diet		0.60	0.09	0.42	0.66	0.99
Housing		0.03	0.40	0.02	0.40	0.55
Diet*Housing		0.54	0.61	0.94	0.92	0.29

Means with the same letter in the same column are not significantly different ($P > 0.05$).

were used; individual stalls and group (modified free access housing). Free access housing ("walk-in lock-in" stalls) allows sows access to feed in a non-competitive environment, however they can leave the stall when desired. To accommodate the experiment, these sows were locked in for individual, controlled feeding and then forced out of their stalls into a group pen for the remainder of the day. Treatment groups were balanced across parities.

Sows began consuming treatment diets 4 to 5 weeks post-breeding. They were fed 2.3 kg per day as per normal barn practice. Water was available in stalls and in the group areas. Sows were moved into a farrowing room 1 week prior to expected farrowing. Sows were weighed when they entered gestation, farrowing and weaning (day 28 of lactation). Piglets were weighed 3 days post-birth and at weaning.

Feed and fecal samples were obtained in gestation and lactation to allow estimation of Ca balance. Milk and blood samples were analysed for Ca and P. Blood was also analysed for biomarkers indicative of bone mobilization. A sub-sample group of sows were equipped with activity monitors and were video-taped to allow estimation of activity.

RESULTS AND DISCUSSION

Sows housed in groups were heavier at day 100 of gestation than those in stalls, despite no difference in feed intake ($P < 0.05$; Table 1). Moreover, sows housed in groups had larger litter size and heavier piglets ($P < 0.05$; Table 2). Diet had only modest effects on production parameters, however there was an apparent diet by housing interaction for serum calcium at day 100 of gestation



Table 3. The effect of dietary Ca & P (15% variance from 1998 NRC recommendations) and housing on sow serum calcium and phosphorus levels

Diet	Housing	Serum Calcium (mmol/L)				Serum Phosphorus (mmol/L)			
		Day 0	Day 100	Mid-Lac	Wean	Day 0	Day 100	Mid-Lac	Wean
-15% Ca	Stall	2.47	2.33 ^a	2.46	2.43	2.23	2.15 ^a	2.11	2.19
	Group	2.40	2.18 ^b	2.43	2.39	2.20	2.05 ^b	2.01	2.07
Control Ca	Stall	2.44	2.28 ^{ab}	2.43	2.40	2.27	2.14 ^a	2.17	2.14
	Group	2.41	2.31 ^{ab}	2.44	2.39	2.13	2.13 ^b	2.14	2.18
+15% Ca	Stall	2.43	2.35 ^a	2.46	2.40	2.21	2.21 ^a	2.18	2.25
	Group	2.41	2.32 ^a	2.47	2.39	2.14	2.11 ^b	2.18	2.14
SEM		0.046	0.037	0.028	0.031	0.051	0.041	0.060	0.057
Statistical Analysis		P Value				P Value			
Diet		0.88	0.05	0.34	0.72	0.65	0.32	0.21	0.48
Housing		0.10	0.06	0.62	0.36	0.03	0.02	0.65	0.16
Diet*Housing		0.68	0.02	0.58	0.70	0.39	0.38	0.80	0.21

Means with the same letter in the same column are not significantly different ($P > 0.05$).

where serum Ca was low in sows fed the low Ca diet, but only in sows housed in groups (Table 3). This could be a result of increasing fetal weight, since they also had more piglets born. Serum P showed similar tendencies when diet Ca:P ratio remained similar (Table 3).

CONCLUSION

We conclude that current NRC recommendations for dietary Ca and P for gestating sows is adequate regardless of housing. Moreover, in this study, housing in groups during gestation improved sow production, as indicated by increased litter size. Sows were not required to compete for food in our housing system, which may be a concern with some group housing systems and should be taken into consideration if reductions in performance are observed.

ACKNOWLEDGEMENTS

Strategic funding provided by Sask Pork, Alberta Pork, Manitoba Pork Council and Saskatchewan Agriculture and Food Development Fund. Specific project funding was provided by the Canadian Swine Research and Development Cluster (Swine Innovation Porc).

Publications List

- Alvarado, A.** and **B. Predicala.** 2012. Assessment of occupational exposure risk of swine production facility workers. Project#AB1101. Progress Report #3 submitted to Agriculture and Food Council of Alberta. October 2012.
- Alvarado, A.** and **B. Predicala.** 2012. Use of nanoparticles to control greenhouse gas emissions and bioaerosols in livestock operations. Project#AB1103. Progress Report #3 submitted to Agriculture and Food Council of Alberta. October 2012.
- Alvarado, A., B. Predicala.** and Y. Jin. 2012. Developing strategies for water conservation for producers. Centred on Swine. Prairie Swine Centre. Saskatoon, SK. 17(2):6-7.
- Alvarado, A., B. Predicala.** and Y. Jin. 2012. Reducing water consumption in swine barns: alternatives for animal drinking and barn cleaning. Poster presented at the 2012 Saskatchewan Pork Industry Symposium. Saskatoon, SK. November 13-14, 2012.
- Alvarado, A., B. Predicala.,** M. Girard, M. Belzile, S. Lemay and J. Feddes. 2013. Effectiveness of an Innovative Air Cleaning System for Reducing Ammonia, Dust and Odour Emissions from Swine Barns. *Advances in Pork Production*. Vol.24. Abst.#13.
- Beaulieu, A.D.** and R.T. Zijlstra. 2012. Feeding low starch diets to swine. *J. Anim. Sci.* 90 (e-Suppl. 3):404
- Beaulieu, A.D., D.A. Gillis, J.N. Shea, J.P. Marriott** and J.F. Patience. 2012. The utilization of energy by pigs differing in growth potential. *J. Anim. Sci.* 90 (e-Suppl 3): 61.
- Beaulieu, A.D., J.N. Shea** and **D.A. Gillis.** 2013. The efficiency of energy utilization by finishing pigs selected for potential growth rate. PSC. Annual Report 2012
- Beaulieu, A.D.,** T.A. Scott and **K. Engele.** 2013. Minimizing the effect of ingredient variation on your bottom line.. Proc. 49th. Eastern Nutrition Conf. Quebec p. 105-119.
- Beaulieu, A.D.** 2012. Achieving feed efficiency targets with diverse ingredients. 2012 Allen. D. Leman Swine Conf. p. 139-144.
- Beaulieu, A.D.** and **J.N. Shea.** 2012. The overall response of piglets to phase one diets during the first two weeks in the nursery is not affected by creep feeding or weaning weight. Centred on Swine. Fall 2012.
- Brown, J.A.,** B.M. Scheeren, L. Faucitano, R. Bergeron, T.M. Widowski, T. Crowe, and **H.W. Gonyou.,** (2012). Truck compartment and trip duration affect pork quality of pigs transported under Canadian conditions. Animal Transportation Association 38th Annual Meeting, Vancouver, BC.
- Damdinsuren, U., **L. Eastwood,** and **A.D. Beaulieu.** 2012. Effect of altering the dietary n-6 to n-3 fatty acid ratio on the pro-inflammatory responses of newly weaned pigs when challenged with *E. coli* lipopolysaccharide. *J. Anim. Sci.* 90 (e-Suppl. 2): 110.
- Dominguez, L.** and **B. Predicala.** 2012. Evaluation of heat exchanger, ground source heat pump, and conventional heating systems in swine grow-finish rooms. 2011 Annual Research Report. Prairie Swine Centre. Saskatoon, SK. pp.18-20.
- Dominguez, L., B. Predicala** and **A. Alvarado.** 2013. Evaluation of heat exchanger, ground source heat pump, and conventional heating systems in swine grow-finish rooms. IRHACE – Journal for the New Zealand Refrigeration, Heating, Ventilation & Airconditioning Industries. Auckland, New Zealand. pp.24-27.
- Eastwood L.** and **A.D. Beaulieu.** 2013. Effects of Altering the Omega-6 to Omega-3 Fatty Acid Ratio in Starter Diets on Piglet Inflammatory Response. PSC. Annual Report 2012
- Eastwood L., J.N. Shea, D.A. Gillis.,** L. Johnston. and **A.D. Beaulieu.** 2013 Spray-dried animal plasma mitigates the negative impact of deoxynivalenol (DON) in nursery pigs. PSC. Annual Report 2012
- Eastwood, L., A.D. Beaulieu** and P. Leterme. 2012. Effect of altering the dietary omega-6 to omega-3 fatty acid profile of sow diets on the immune responses of their offspring when challenged with *E. coli* lipopolysaccharide. *J. Anim. Sci.* 90 (e-Suppl 3): 756.
- Eastwood, L., J.N. Shea, D. Gillis** and **A.D. Beaulieu.** 2013. Spray-dried animal plasma mitigates the negative impact of deoxynivalenol (DON) in nursery pigs. *J. Anim. Sci.* 91(Suppl 2) 32.
- Eastwood, L.,** P. Leterme and **A.D. Beaulieu.** 2012. Dietary n-6 to n-3 ratio affects body fat mobilization during lactation in high-producing sows. *J. Anim. Sci.* 90 (e-Suppl 2): 113.
- Edwards, S.A., Brett, M., **Y.M Seddon,** D. Ross, and E.M. Baxter, (2012). Evaluation of nest design and nesting substrate options for the PigSAFE free farrowing pen. In Proceedings of the British Society of Animal Science, Annual Meeting, April 2012. pp7
- Edwards, S.A., M. Brett, S. Ison, M. Jack, **Y.M. Seddon,** and E.M. Baxter. (2012) Design principles and practical evaluation of the PigSAFE free farrowing pen. In Proceedings of the 4th European Symposium on Porcine Health Management, Ghent, Belgium, pp113.
- Engele, K.M.** and **D.L. Whittington.** Investigating the Value of Air Filtration in Herd Biosecurity. *Western Hog Journal*, Fall 2012. Pp59-61.

Gonyou, H.W. and **F.C. Rioja-Lang.** 2012. Competitive Feeding Systems. Prairie Swine Centre, Science of Ethology, Vol 1, Issue 2.

Gonyou, H.W. and **F.C. Rioja-Lang.** 2012. Non-Competitive Feeding Systems: Gated Stalls. Prairie Swine Centre, Science of Ethology, Vol 1, Issue 3.

Goumon, S, **J.A. Brown**, L. Faucitano, R. Bergeron, T. Crowe, L. Connor, and **H.W. Gonyou.** Effect of rest interval on recovery from repeated exercise in near market-weight pigs. Submitted to JAS. Dec 2012.

Goumon, S, **J.A. Brown**, L. Faucitano, R. Bergeron, T. Widowski, T. Crowe, L. Connor, and **H.W. Gonyou.** Effects of transport duration on behavior, heart rate and gastrointestinal tract temperature of market weight pigs in 2 seasons. Submitted to JAS. Dec 2012.

Goumon, S, **J.A. Brown**, L. Faucitano, R. Bergeron, T.M. Widowski, T. Crowe, **H.W. Gonyou.** (2012). Effects of season and transport duration on behaviour, heart rate and body temperature of market weight pigs. Animal Transportation Association 38th Annual Meeting, Vancouver, BC.

Guy, J.H., P.J. Cain, **Y.M. Seddon**, E.M. Baxter, and S.A. Edwards. (2012) Economic evaluation of high welfare indoor farrowing systems for pigs. Animal Welfare. 21 (SUPPL. 1), pp. 19 – 24.

Martel, M., S.P. Lemay, **B.P. Predicala**, M. Girard, R. Hogue, M. Belzile, J. Feddes and S. Godbout. 2012. Steady-state model for ammonia removal from swine facility air with a cross-flow biotrickling filter: model development and sensitivity analysis. Paper No. CSBE12-127. Presented at 2012 NABEC-CSBE/SCGAB Joint Meeting and Technical Conference. Canadian Society for Bioengineering. Orillia, Ontario. July 15-18, 2012.

Martel, M., S.P. Lemay, **B. Predicala**, M. Girard, R. Hogue, M. Belzile, J. Feddes and S. Godbout. 2012. Steady-state model for ammonia removal from swine facility air with a cross-flow biotrickling filter: calibration and validation. Paper No. CSBE12-126. Presented at 2012 NABEC-CSBE/SCGAB Joint Meeting and Technical Conference. Canadian Society for Bioengineering. Orillia, Ontario. July 15-18, 2012.

Moreno, L., M. Nemati and **B. Predicala.** 2012. Treatment of model organic compounds in microbial fuel cell type bioreactors. Paper No. 253. Presented at the 2nd International Conference on Environmental Pollution and Remediation. Montreal, Quebec, Canada. August 28-30, 2012.

Mussel, A., C. Schmidt, I. Rajcan, B. Kemp, H. Gauvreau, **D.L. Whittington.** 2013. An Economic Analysis of the value of imported live pigs and semen from outside North America compare to the risk of introducing a new emerging pathogen to the commercial pig industry in Canada and an evaluation of the potential mitigation measures. Prepared for Canadian Swine Health Board, April 2013.

Pouliot, F., C. Duchaine, V. Letorneau, D. Reicks, S. Messier, F. Cardinal, B. Jones, **B. Predicala**, M. Morin, R. MacDonald. 2012. Minimizing the risk of contamination in Canadian swine barns with air filtration systems. Presented at the 2012 Canadian Swine Health Forum. Sponsored by the Canadian Swine Health Board. Winnipeg, MB. 17 October 2012.

Predicala, B. 2013. Conserving water in intensive hog operations. Agriview. Saskatchewan Ministry of Agriculture. Regina, SK. Vol. 9, Issue 3. p11.

Predicala, B. and **A. Alvarado.** 2012. Reducing water consumption in swine barns: alternatives for animal drinking and barn cleaning. 2011 Annual Research Report. Prairie Swine Centre. Saskatoon, SK. 2011 Annual Research Report. Prairie Swine Centre. Saskatoon, SK. pp.21-23.

Predicala, B. and **A. Alvarado.** 2012. Using zinc oxide nanoparticles to control emissions – pig performance, manure properties, and production cost. 2011 Annual Research Report. Prairie Swine Centre. Saskatoon, SK. pp.15-17.

Predicala, B. and H. Bonifacio. 2012. Design and development of an emergency biocontainment system to isolate swine facilities following an outbreak of transmissible airborne diseases. Progress Report submitted to Canadian Swine Health Board. August 2012.

Predicala, B. and H. Bonifacio. 2012. Development of an air-filtration system for animal transport vehicles to prevent airborne transmission of diseases in swine. Project#P25-C. Progress Report #1 submitted to Agriculture Council of Saskatchewan. October 2012.

Predicala, B. and H. Bonifacio. 2012. Development of an air-filtration system for animal transport vehicles to prevent airborne transmission of diseases in swine. Progress Report submitted to Canadian Swine Health Board. August 2012.

Predicala, B., A. Alvarado and **D. Asis.** 2012. Use of zinc oxide nanoparticles to control hydrogen sulphide, ammonia and odour emissions from pig barns. Paper No. ILES12-1507. Presented at the 9th International Livestock Environment Symposium. American Society of Agricultural and Biological Engineers. Valencia, Spain. July 8-12, 2012.

Predicala, B., A. Alvarado, M. Girard, M. Belzile, S. Lemay and J. Feddes. 2013. Evaluation of a biotrickling filtration system for treatment of exhaust air from a swine barn. Centred on Swine. Prairie Swine Centre. Saskatoon, SK. 18(2):8-11.

Rioja-Lang, F.C., D. J. Roberts, S.D. Healy, M.J. Haskell, 2012. Dairy cow feeding space requirements assessed in a Y-maze choice test. J. Dairy Sci. 95, 3954-4962.

Rioja-Lang, F.C., J.A. Brown, and **H.W. Gonyou.** 2012. Investigating the effect of rubber flooring and social grouping on the utilisation of free space for sows in free access stalls. Proceedings of the International Society of Applied Ethology, Regional Meeting, Banff.

- S. Torrey, R. Bergeron, L. Faucitano, T. Widowski, N. Lewis, T. Crowe, J.A. Correa, **J.A. Brown**, S. Hayne, and **H.W. Gonyou**, 2013. Transportation of market-weight pigs 1. Effect of season, truck type, and location within truck on behavior with a 2-h transport. *JAS*; published ahead of print March 11, 2013, doi:10.2527/jas.2012-6005
- S. Torrey, R. Bergeron, L. Faucitano, T. Widowski, N. Lewis, T. Crowe, J.A. Correa, **J.A. Brown**, S. Hayne, and **H.W. Gonyou**, 2013. Transportation of market-weight pigs 2. Effect of season and location within truck on behavior with an 8-h transport. *JAS*; published ahead of print March 11, 2013, doi:10.2527/jas.2012-6006
- Schmidt, C K Grier, A. Mussel, **D.L. Whittington**, **A.D. Beaulieu**, **B. Predicala**, **A. Alvarado**, M. Morin. 2012. Water Quality Impacts of Hog Farms, commissioned by Environment Canada.
- Seddon, Y.M., J.A. Brown**, T. Crowe, R. Bergeron, T. Widowski, L. Faucitano, and **H.W. Gonyou**. (2012) Trailer compartment and trip duration affect stress of pigs transported under Canadian conditions. Proceedings of the Joint Annual Meeting of the American Society of Animal Science, Phoenix, Arizona, 15th – 19th July, pp. 255.
- Seddon, Y.M.**, J.H. Guy, and S.A. Edwards. (2012) Optimising oral fluid collection from groups of pigs: Effect of housing system and provision of ropes. *The Veterinary Journal*. 193, (1), pp. 180 – 184.
- Shea, J.N., D.A. Gillis** and **A.D. Beaulieu**. 2011. The effect of diet and creep feed on feed intake by weanling pigs. *J. Anim. Sci.* 89 (e-Suppl 1):582.
- Shea, J.N., A.D. Beaulieu, D.A. Gillis** and **J.A. Brown**. 2013. Creep feeding in the farrowing room: do the outcomes depend on the weaning age? *PSC. Annual Report 2012*.
- Tan, F.P.** and **A.D. Beaulieu**. 2013. Impact of Calcium and Phosphorus on Sow Lameness and Sow Longevity. *PSC. Annual Report 2012*.
- Webb, John, D.L. Whittington, M. J. Tergeron, S. Cressman, G. Foxcroft, J.P. LaForest, S. Joyal, 2012. Canadian Pork Industry Research Priorities for Cluster II Strategy, Commissioned by Swine Innovation Porc.
- Whittington D.L., B. Predicala, A. Alvarado, F. Pouliot, R. MacDonald, J. Agnew, H. Huffman, F. Kains. 2013. Development of Standards for Swine Production Systems, CSRD project #1011
- Whittington, D.L. 2012. Swine Nutrition Research Impacts productivity and Profits, PSC/Elanco producer meetings, Niverville, MB. April 18.
- Whittington, D.L. 2012. Swine Nutrition Research Impacts productivity and Profits, PSC/Elanco producer meetings, Portage La Prairie, MB. April 17.
- Whittington, D.L. 2012. Swine Nutrition Research Impacts productivity and Profits, PSC/Elanco producer meetings, Red Deer, AB. March 14.
- Whittington, D.L.** 2012. Swine Nutrition Research Impacts productivity and Profits, PSC/Elanco producer meetings, Lethbridge, AB March 13.
- Whittington, D.L.** 2012. Swine Nutrition Research Impacts productivity and Profits, PSC/Elanco producer meetings, Niverville, MB. April 18..
- Whittington, D.L.** 2012. Swine Research and Prairie Swine Centre, PSC/Elanco producer meetings, Saskatoon, SK. Mar. 2
- Whittington, D.L.** 2012. Swine Research and Prairie Swine Centre, PSC/Elanco producer meetings, Stratford, ON. Feb. 28.
- Whittington, D.L.** 2013. Contract Research Services – We do Research Its our Job. Centred on Swine. Prairie Swine Centre Inc., Saskatoon SK. Vol 18 (No2)
- Whittington, D.L.** 2012. Prairie Swine Centre Turns 20 in 2012, time for thinking Outside the Box – Again. Centred on Swine. Prairie Swine Centre Inc., Saskatoon SK. Vol 17 (No 2)
- Whittington, D.L.** 2012. Appointment of new Board members to PSC Board. February
- Whittington, D.L.** Appointment of Stefanyshyn-Cote to Manager Contract Research Services, February
- Whittington, D.L.** 2012. Prairie Swine Centre Serving the Pork Value Chain – Engaging Partners in the Pursuit of Excellence, Prairie Swine Centre Inc, Saskatoon, SK.
- Whittington, D.L.** 2013. Appointment of new members to PSC Board of Directors. March
- Whittington, D.L.** 2013. Past, Present and Future of the Canadian Pork Industry. PEI Hog Commodity Marketing Board Annual Meeting. Charlottetown, March 14
- Whittington, D.L.** 2013. Past, Present and Future of the Canadian Pork Industry. South Western Ontario Pork Congress, Ridgeway, February 20
- Whittington, D.L.** 2013. Workshop on Improving Net Income in Pork Production. PEI Hog Commodity Marketing Board Annual Meeting. Charlottetown, March 14
- Whittington, D.L.** 2012 Annual research Report Released, August
- Whittington, D.L.** 2013. Appointment of Helen Thoday to Manager Contract Research Services. June
- Whittington, D.L. K. Carr, A.D. Beaulieu**, and **D.A. Gillis**. 2012. Nutrition of the Hog and Greenhouse Gas Production. Commissioned by James Douglas Macdonald, Agricultural Scientist, Pollutant Inventories and Reporting, Science and Risk Assessment Directorate, Environment Canada.
- Whittington, D.L.,** Schmidt C., A. Mussel, J. Forest, J. Brown, **Y.M. Seddon**, 2013. Assessing the Economic Risk of Canadian Swine Genetics Imports, prepared for Canada Pork Council.

Financial Support

Prairie Swine Centre Inc. wants to recognize the many individuals and agencies that supported the research and technology transfer programs this year. Their support is essential to the ongoing developments that will keep Canadian pork producers at the forefront of applied technology.

In addition to the many industry and government funding agencies, the University of Saskatchewan contracts the facilities and services of PSCI for research and teaching.

The following organizations have provided funding or donations in kind to support public research at the Centre for the 2012-13 fiscal year.

PROGRAM SPONSORS

Agriculture Development Fund (ADF)
 Alberta Pork Producers Development Corporation
 Manitoba Pork Council
 Saskatchewan Pork Development Board
 Ontario Pork Producer's Marketing Board

MAJOR PROJECT SPONSORS

Alberta Livestock and Meat Agency
 Canadian Swine Research and Development Cluster
 Manitoba Livestock and Manure Management Initiative
 National Pork Board
 Natural Sciences and Engineering Research Council of Canada
 Saskatchewan Pulse Crop Marketing Board

PROJECT SPONSORS

ADOPT - Saskatchewan Pork Development Board
 Alberta Agriculture and Rural Development
 Alberta Farm Animal Council
 Agriculture and Agri-Food Canada
 Canadian Agricultural Adaptation Program
 Cargill
 Environment Canada
 Maple Leaf Fresh Foods